

有关敝司产品的注意事项

请务必在使用敝司产品之前阅读。

⚠ 注意

■ 本产品目录所记载的内容为2016年10月之内容。因改良等原因，可能会不经预告而变更记载内容，所以请务必在使用前先确认最新的产品信息。未按照本产品目录所记载的内容或交货规格说明书使用敝司产品的，即便其致使使用设备发生损害、瑕疵等时，敝司也不承担任何责任，敬请悉知。

■ 就规格相关的详细内容，敝司备有交货规格说明书，详情请向敝司咨询。

■ 使用敝司产品时，请务必事先安装到设备之后，在实际使用的环境下进行评估和确认。

■ 本产品目录中所记载的产品可使用于一般电子设备 [音像设备、办公自动化设备、家电产品、办公设备、信息/通讯设备 (手机、电脑等)]。因此，若考虑将本产品目录所记载的产品使用于可能会直接危及生命或身体的设备 [运输用设备 (汽车驱动控制设备、火车控制设备、船舶控制设备等)、交通信号设备、防灾设备、医疗用器械、高公共性信息通信设备 (电话交换机以及电话、无线、广播电视等基站)] 等时，请务必事先向敝司咨询。

另外，请勿将敝司产品使用于对安全性和可靠性要求较高的设备 (航天设备、航空设备、原子能控制设备、海底设备、军事设备等)。

且即便属于一般电子设备，使用于对安全性和可靠性要求较高的设备、电路上时，敝司建议进行充分的安全评估，并根据需要，在设计时追加保护电路等。

未经敝司的事先书面同意，把本产品目录中记载的产品使用于前述需要向敝司咨询的设备或敝司禁止使用的设备，从而给客户或第三方造成的损害的，敝司不承担任何责任，敬请悉知。

■ 因使用敝司产品，发生第三方的知识产权等权利相关问题的，敝司不承担责任。另外，并不代表授予这些权利的实施权，敬请悉知。

■ 除非书面合同中另有规定，敝司产品的保证范围仅限于交付的敝司产品单品，并且就敝司产品的故障或瑕疵所导致的损害，敝司不承担任何责任，敬请悉知。

■ 本产品目录所记载的内容适用于从敝司营业所、销售子公司、销售代理店 (即“正规销售渠道”) 购买的敝司产品，并不适用于从上述以外的渠道购买的敝司产品，敬请悉知。

■ 出口相关注意事项

本产品目录所记载的部分产品在出口时须事先确认《外汇和对外贸易法》以及美国出口管理的相关法规，并办理相关手续。如有不明之处，请向敝司咨询。

多层高频片状电感器 (HK 系列)



波峰焊※

回流焊

※HK0603, HK1005除外

■ 型号标示法

※使用温度范围: -55~+125°C (HK1608/2125: -40~+85°C)

H	K	△	0	6	0	3	△	1	0	N	J	-	T
①			②					③			④		⑤

△ = 空格

① 类型

代码	类型
HK△	多层高频片状电感器

② 尺寸 (L×W)

代码	外型 (inch)	尺寸 (L×W) [mm]
0603	0603 (0201)	0.6×0.3
1005	1005 (0402)	1.0×0.5
1608	1608 (0603)	1.6×0.8
2125	2125 (0805)	2.0×1.2

③ 标称电感值

代码 (例)	标称电感值 [nH]
3N9	3.9
10N	10.0
R10	100
R12	120

※R=小数点

※N=nH的小数点

④ 电感量公差

代码	电感量公差
J	±5%
S	±0.3nH

⑤ 包装

代码	包装
-T	卷盘带装

■ 标准外型尺寸 / 标准数量

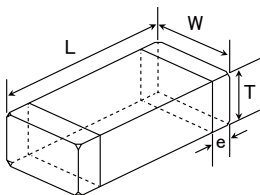

Type	L	W	T	e	标准数量 [pcs]	
					纸带	压纹带
HK 0603 (0201)	0.6±0.03 (0.024±0.001)	0.3±0.03 (0.012±0.001)	0.3±0.03 (0.012±0.001)	0.15±0.05 (0.006±0.002)	15000	—
HK 1005 (0402)	1.0±0.05 (0.039±0.002)	0.5±0.05 (0.020±0.002)	0.5±0.05 (0.020±0.002)	0.25±0.10 (0.010±0.004)	10000	—
HK 1608 (0603)	1.6±0.15 (0.063±0.006)	0.8±0.15 (0.031±0.006)	0.8±0.15 (0.031±0.006)	0.3±0.2 (0.012±0.008)	4000	—
HK 2125 (0805)	2.0+0.3/-0.1 (0.079+0.012/-0.004)	1.25±0.2 (0.049±0.008)	0.85±0.2 (0.033±0.008)	0.5±0.3 (0.020±0.012)	—	4000
	2.0+0.3/-0.1 (0.079+0.012/-0.004)	1.25±0.2 (0.049±0.008)	1.0+0.2/-0.3 (0.039+0.008/-0.012)	0.5±0.3 (0.020±0.012)	—	3000

单位: mm (inch)

▶ 由于篇幅有限, 本产品目录中只记载了有代表性的产品规格, 若考虑使用弊公司产品时, 请确认交货规格说明书中的详细规格。另外, 有关各产品的详细信息(特性图、可靠性信息、使用时的注意事项等), 请参阅弊司网站(<http://www.ty-top.com/>)。

多层高频High-Q 片状电感器(HK 系列 Q 型/AQ 系列)



回流焊

■ 型号标示法

※使用温度范围: -55~+125°C

H	K	Q	0	6	0	3	S	1	0	N	J	-	T	
①			②				③				④		⑤	⑥

△=空格

①类型

代码	类型
HKQ	多层高频High-Q 片状电感器
AQ△	

②尺寸 (L×W)

代码	外型 (inch)	尺寸 (L×W) [mm]
0402	0402(01005)	0.4×0.2
0603	0603(0201)	0.6×0.3
105△	105(0402)	1.0×0.6

③系列码

代码	系列码
△	标准品
W	W
C	C
S	S
U	U

④标称电感值

代码 (例)	标称电感值 [μH]
3N9	3.9
10N	10.0

※N=nH 的小数点

⑤电感量公差

代码	容量公差
H	±3%
J	±5%
B	±0.1nH
C	±0.2nH
S	±0.3nH

⑥包装

代码	包装
-T	卷盘带装
-E	压纹带1mm 间距0402 专用

■ 标准外型尺寸 / 标准数量

HKQ0402、HKQ0603S、HKQ0603U、AQ 105

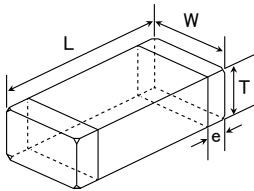

HKQ0603W 0N6~24N
HKQ0603C

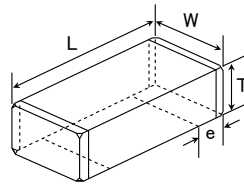

HKQ0603W 27N~R10

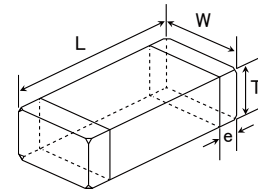

Type	L	W	T	e	标准数量 [pcs]	
					纸带	压纹带
HKQ0402 (01005)	0.4±0.02 (0.016±0.001)	0.2±0.02 (0.008±0.001)	0.2±0.02 (0.008±0.001)	0.1±0.03 (0.004±0.001)	20000	40000
HKQ0603W HKQ0603C (0201)	0.6±0.03 (0.024±0.001)	0.3±0.03 (0.012±0.001)	0.3±0.03 (0.012±0.001)	0.15±0.05 (0.006±0.002)	15000	—
HKQ0603S HKQ0603U (0201)	0.6±0.03 (0.024±0.001)	0.3±0.03 (0.012±0.001)	0.3±0.03 (0.012±0.001)	0.1±0.05 (0.004±0.002)	15000	—
AQ 105 (0402)	1.0±0.05 (0.039±0.002)	0.6±0.1 (0.024±0.004)	0.5±0.05 (0.020±0.002)	0.175±0.075 (0.007±0.003)	10000	—

单位: mm (inch)

▶ 由于篇幅有限, 本产品目录中只记载了有代表性的产品规格, 若考虑使用弊公司产品时, 请确认交货规格说明书中的详细规格。另外, 有关各产品的详细信息(特性图、可靠性信息、使用时的注意事项等), 请参阅弊网站(<http://www.ty-top.com/>)。

HKQ0603C

型号	EHS	标称电感值 [nH]	电感量公差	Q值 (min.)	LQ 测试频率 [MHz]	Q (Typical) 频率 [Hz]					自共振频率 [MHz] (min.)	直流电阻 DC [Ω] (max.)	额定电流 [mA] (max.)	厚度 [mm]
						500M	800M	1.8G	2.0G	2.4G				
HKQ0603C0N6[]-T	RoHS	0.6	±0.1nH, ±0.2nH, ±0.3nH	15	500	36<	46<	78<	82<	91<	10000	0.07	850	0.30 ±0.03
HKQ0603C0N7[]-T	RoHS	0.7	±0.1nH, ±0.2nH, ±0.3nH	15	500	36<	46<	78<	82<	91<	10000	0.07	850	0.30 ±0.03
HKQ0603C0N8[]-T	RoHS	0.8	±0.1nH, ±0.2nH, ±0.3nH	15	500	36<	46<	78<	82<	91<	10000	0.07	850	0.30 ±0.03
HKQ0603C0N9[]-T	RoHS	0.9	±0.1nH, ±0.2nH, ±0.3nH	15	500	36<	46<	78<	82<	91<	10000	0.09	760	0.30 ±0.03
HKQ0603C1N0[]-T	RoHS	1	±0.1nH, ±0.2nH, ±0.3nH	15	500	36<	46<	78<	82<	91<	10000	0.12	680	0.30 ±0.03
HKQ0603C1N1[]-T	RoHS	1.1	±0.1nH, ±0.2nH, ±0.3nH	15	500	36<	46<	78<	82<	91<	10000	0.10	750	0.30 ±0.03
HKQ0603C1N2[]-T	RoHS	1.2	±0.1nH, ±0.2nH, ±0.3nH	15	500	36	46	78	82	91	10000	0.10	750	0.30 ±0.03
HKQ0603C1N3[]-T	RoHS	1.3	±0.1nH, ±0.2nH, ±0.3nH	15	500	36	44	71	75	85	10000	0.12	650	0.30 ±0.03
HKQ0603C1N4[]-T	RoHS	1.4	±0.1nH, ±0.2nH, ±0.3nH	15	500	35	44	69	72	82	10000	0.12	650	0.30 ±0.03
HKQ0603C1N5[]-T	RoHS	1.5	±0.1nH, ±0.2nH, ±0.3nH	15	500	34	43	65	69	77	10000	0.12	650	0.30 ±0.03
HKQ0603C1N6[]-T	RoHS	1.6	±0.1nH, ±0.2nH, ±0.3nH	15	500	30	38	60	62	71	10000	0.14	610	0.30 ±0.03
HKQ0603C1N7[]-T	RoHS	1.7	±0.1nH, ±0.2nH, ±0.3nH	15	500	28	35	54	57	64	10000	0.14	610	0.30 ±0.03
HKQ0603C1N8[]-T	RoHS	1.8	±0.1nH, ±0.2nH, ±0.3nH	15	500	27	34	53	55	62	10000	0.14	610	0.30 ±0.03
HKQ0603C1N9[]-T	RoHS	1.9	±0.1nH, ±0.2nH, ±0.3nH	15	500	27	34	53	55	62	10000	0.14	610	0.30 ±0.03
HKQ0603C2N0[]-T	RoHS	2	±0.1nH, ±0.2nH, ±0.3nH	15	500	26	33	53	55	62	10000	0.14	610	0.30 ±0.03
HKQ0603C2N1[]-T	RoHS	2.1	±0.1nH, ±0.2nH, ±0.3nH	15	500	25	32	52	54	61	10000	0.14	610	0.30 ±0.03
HKQ0603C2N2[]-T	RoHS	2.2	±0.1nH, ±0.2nH, ±0.3nH	15	500	25	32	52	54	61	10000	0.14	610	0.30 ±0.03
HKQ0603C2N3[]-T	RoHS	2.3	±0.1nH, ±0.2nH, ±0.3nH	15	500	25	32	52	54	61	10000	0.16	560	0.30 ±0.03
HKQ0603C2N4[]-T	RoHS	2.4	±0.1nH, ±0.2nH, ±0.3nH	15	500	25	32	51	53	61	10000	0.16	560	0.30 ±0.03
HKQ0603C2N5[]-T	RoHS	2.5	±0.1nH, ±0.2nH, ±0.3nH	15	500	24	32	51	53	60	8500	0.16	560	0.30 ±0.03
HKQ0603C2N6[]-T	RoHS	2.6	±0.1nH, ±0.2nH, ±0.3nH	15	500	24	32	50	52	56	8500	0.16	560	0.30 ±0.03
HKQ0603C2N7[]-T	RoHS	2.7	±0.1nH, ±0.2nH, ±0.3nH	15	500	23	31	48	49	54	8500	0.19	510	0.30 ±0.03
HKQ0603C2N8[]-T	RoHS	2.8	±0.1nH, ±0.2nH, ±0.3nH	15	500	23	31	48	50	53	8500	0.20	500	0.30 ±0.03
HKQ0603C2N9[]-T	RoHS	2.9	±0.1nH, ±0.2nH, ±0.3nH	15	500	23	31	48	49	52	8500	0.20	500	0.30 ±0.03
HKQ0603C3N0[]-T	RoHS	3	±0.1nH, ±0.2nH, ±0.3nH	15	500	22	31	46	47	52	8500	0.20	500	0.30 ±0.03
HKQ0603C3N1[]-T	RoHS	3.1	±0.1nH, ±0.2nH, ±0.3nH	15	500	22	30	46	48	52	8500	0.20	500	0.30 ±0.03
HKQ0603C3N2[]-T	RoHS	3.2	±0.1nH, ±0.2nH, ±0.3nH	15	500	22	30	46	48	52	8500	0.20	500	0.30 ±0.03
HKQ0603C3N3[]-T	RoHS	3.3	±0.1nH, ±0.2nH, ±0.3nH	15	500	22	30	45	46	50	8000	0.20	500	0.30 ±0.03
HKQ0603C3N4[]-T	RoHS	3.4	±0.1nH, ±0.2nH, ±0.3nH	15	500	22	30	46	47	50	8000	0.20	500	0.30 ±0.03
HKQ0603C3N5[]-T	RoHS	3.5	±0.1nH, ±0.2nH, ±0.3nH	15	500	22	29	45	46	50	8000	0.20	500	0.30 ±0.03
HKQ0603C3N6[]-T	RoHS	3.6	±0.1nH, ±0.2nH, ±0.3nH	15	500	22	29	45	46	50	7000	0.20	500	0.30 ±0.03
HKQ0603C3N7[]-T	RoHS	3.7	±0.1nH, ±0.2nH, ±0.3nH	15	500	22	28	43	44	48	7000	0.20	500	0.30 ±0.03
HKQ0603C3N8[]-T	RoHS	3.8	±0.1nH, ±0.2nH, ±0.3nH	15	500	22	28	43	44	47	7000	0.20	500	0.30 ±0.03
HKQ0603C3N9[]-T	RoHS	3.9	±0.1nH, ±0.2nH, ±0.3nH	15	500	22	28	43	43	47	7000	0.25	440	0.30 ±0.03
HKQ0603C4N3[]-T	RoHS	4.3	±0.2nH, ±0.3nH	15	500	21	29	43	44	47	6000	0.30	400	0.30 ±0.03
HKQ0603C4N7[]-T	RoHS	4.7	±0.2nH, ±0.3nH	15	500	21	29	42	42	45	6000	0.35	370	0.30 ±0.03
HKQ0603C5N1[]-T	RoHS	5.1	±0.2nH, ±0.3nH	15	500	21	27	41	41	44	6000	0.35	370	0.30 ±0.03
HKQ0603C5N6[]-T	RoHS	5.6	±0.2nH, ±0.3nH	15	500	21	28	40	40	43	6000	0.35	370	0.30 ±0.03
HKQ0603C6N2[]-T	RoHS	6.2	±0.2nH, ±0.3nH	15	500	21	27	40	41	41	6000	0.40	340	0.30 ±0.03
HKQ0603C6N8[]-T	RoHS	6.8	±3%, ±5%	15	500	21	27	39	39	40	6000	0.50	310	0.30 ±0.03
HKQ0603C7N5[]-T	RoHS	7.5	±3%, ±5%	14	500	20	27	37	37	39	5000	0.60	300	0.30 ±0.03
HKQ0603C8N2[]-T	RoHS	8.2	±3%, ±5%	14	500	20	27	37	37	40	5000	0.70	250	0.30 ±0.03
HKQ0603C9N1[]-T	RoHS	9.1	±3%, ±5%	14	500	20	26	36	36	39	4000	0.70	250	0.30 ±0.03
HKQ0603C10N[]-T	RoHS	10	±3%, ±5%	14	500	20	26	35	35	37	4000	0.85	220	0.30 ±0.03
HKQ0603C12N[]-T	RoHS	12	±3%, ±5%	14	500	20	26	32	33	34	3000	0.85	220	0.30 ±0.03
HKQ0603C15N[]-T	RoHS	15	±3%, ±5%	14	500	20	24	30	29	27	3000	0.90	200	0.30 ±0.03
HKQ0603C18N[]-T	RoHS	18	±3%, ±5%	14	500	19	24	28	26	25	2500	1.20	180	0.30 ±0.03
HKQ0603C22N[]-T	RoHS	22	±3%, ±5%	14	500	18	23	26	26	22	2500	1.60	160	0.30 ±0.03

※电感值公差标在型号[]中。

▶由于篇幅有限, 本产品目录中只记载了有代表性的产品规格, 若考虑使用弊公司产品时, 请确认交货规格说明书中的详细规格。
另外, 有关各产品的详细规格(特性图、可靠性信息、使用时的注意事项等), 请参阅弊网站(<http://www.ty-top.com/>)。

●HKQ0603S

型号	EHS	标称电感值 [nH]	电感量公差	Q值 (min.)	LQ 测试频率 [MHz]	Q (Typical) 频率 [Hz]					自共振频率 [MHz] (min.)	直流电阻 DC [Ω] (max.)	额定电流 [mA] (max.)	厚度 [mm]
						500M	800M	1.8G	2.0G	2.4G				
HKQ0603S0N6□-T	RoHS	0.6	±0.2nH, ±0.3nH	13	500	>24	>31	>53	>56	>64	10000	0.06	600	0.30 ±0.03
HKQ0603S0N7□-T	RoHS	0.7	±0.2nH, ±0.3nH	13	500	>24	>31	>53	>56	>64	10000	0.07	550	0.30 ±0.03
HKQ0603S0N8□-T	RoHS	0.8	±0.2nH, ±0.3nH	13	500	>24	>31	>53	>56	>64	10000	0.07	550	0.30 ±0.03
HKQ0603S0N9□-T	RoHS	0.9	±0.2nH, ±0.3nH	13	500	>24	>31	>53	>56	>64	10000	0.08	520	0.30 ±0.03
HKQ0603S1N0□-T	RoHS	1.0	±0.2nH, ±0.3nH	13	500	24	31	53	56	64	10000	0.09	490	0.30 ±0.03
HKQ0603S1N1□-T	RoHS	1.1	±0.2nH, ±0.3nH	13	500	19	26	44	47	54	10000	0.12	420	0.30 ±0.03
HKQ0603S1N2□-T	RoHS	1.2	±0.2nH, ±0.3nH	13	500	19	25	42	44	51	10000	0.15	380	0.30 ±0.03
HKQ0603S1N3□-T	RoHS	1.3	±0.2nH, ±0.3nH	13	500	19	25	40	42	47	10000	0.19	330	0.30 ±0.03
HKQ0603S1N4□-T	RoHS	1.4	±0.2nH, ±0.3nH	13	500	19	24	39	41	47	10000	0.11	440	0.30 ±0.03
HKQ0603S1N5□-T	RoHS	1.5	±0.2nH, ±0.3nH	13	500	19	24	39	41	46	10000	0.12	420	0.30 ±0.03
HKQ0603S1N6□-T	RoHS	1.6	±0.2nH, ±0.3nH	13	500	19	24	39	41	46	10000	0.13	410	0.30 ±0.03
HKQ0603S1N7□-T	RoHS	1.7	±0.2nH, ±0.3nH	13	500	19	24	39	41	46	10000	0.15	380	0.30 ±0.03
HKQ0603S1N8□-T	RoHS	1.8	±0.2nH, ±0.3nH	13	500	18	24	39	41	46	10000	0.16	370	0.30 ±0.03
HKQ0603S1N9□-T	RoHS	1.9	±0.2nH, ±0.3nH	13	500	18	23	38	40	45	10000	0.20	330	0.30 ±0.03
HKQ0603S2N0□-T	RoHS	2.0	±0.2nH, ±0.3nH	13	500	17	23	37	39	44	10000	0.24	300	0.30 ±0.03
HKQ0603S2N1□-T	RoHS	2.1	±0.2nH, ±0.3nH	13	500	17	23	37	39	44	10000	0.26	290	0.30 ±0.03
HKQ0603S2N2□-T	RoHS	2.2	±0.2nH, ±0.3nH	13	500	17	23	37	39	43	10000	0.28	270	0.30 ±0.03
HKQ0603S2N3□-T	RoHS	2.3	±0.2nH, ±0.3nH	13	500	17	23	36	38	43	10000	0.30	270	0.30 ±0.03
HKQ0603S2N4□-T	RoHS	2.4	±0.2nH, ±0.3nH	13	500	17	22	36	38	42	10000	0.32	260	0.30 ±0.03
HKQ0603S2N5□-T	RoHS	2.5	±0.2nH, ±0.3nH	13	500	17	22	34	35	39	9500	0.20	330	0.30 ±0.03
HKQ0603S2N6□-T	RoHS	2.6	±0.2nH, ±0.3nH	13	500	17	22	33	35	39	9300	0.22	310	0.30 ±0.03
HKQ0603S2N7□-T	RoHS	2.7	±0.2nH, ±0.3nH	13	500	17	22	33	35	39	9100	0.24	300	0.30 ±0.03
HKQ0603S2N8□-T	RoHS	2.8	±0.2nH, ±0.3nH	13	500	17	22	33	35	39	8900	0.25	290	0.30 ±0.03
HKQ0603S2N9□-T	RoHS	2.9	±0.2nH, ±0.3nH	13	500	17	22	33	35	39	8700	0.28	270	0.30 ±0.03
HKQ0603S3N0□-T	RoHS	3.0	±0.2nH, ±0.3nH	13	500	17	22	33	35	39	8600	0.28	270	0.30 ±0.03
HKQ0603S3N1□-T	RoHS	3.1	±0.2nH, ±0.3nH	13	500	17	22	33	35	39	8400	0.29	270	0.30 ±0.03
HKQ0603S3N2□-T	RoHS	3.2	±0.2nH, ±0.3nH	13	500	17	22	33	35	39	8200	0.30	270	0.30 ±0.03
HKQ0603S3N3□-T	RoHS	3.3	±0.2nH, ±0.3nH	13	500	17	22	33	35	39	8100	0.32	260	0.30 ±0.03
HKQ0603S3N4□-T	RoHS	3.4	±0.2nH, ±0.3nH	13	500	16	22	33	35	39	8000	0.36	240	0.30 ±0.03
HKQ0603S3N5□-T	RoHS	3.5	±0.2nH, ±0.3nH	13	500	16	22	33	35	39	7800	0.40	230	0.30 ±0.03
HKQ0603S3N6□-T	RoHS	3.6	±0.2nH, ±0.3nH	13	500	16	22	33	35	39	7700	0.41	230	0.30 ±0.03
HKQ0603S3N7□-T	RoHS	3.7	±0.2nH, ±0.3nH	13	500	16	22	33	35	38	7600	0.44	220	0.30 ±0.03
HKQ0603S3N8□-T	RoHS	3.8	±0.2nH, ±0.3nH	13	500	16	22	33	35	38	7500	0.48	210	0.30 ±0.03
HKQ0603S3N9□-T	RoHS	3.9	±0.2nH, ±0.3nH	13	500	16	22	33	35	38	7300	0.48	210	0.30 ±0.03
HKQ0603S4N3□-T	RoHS	4.3	±0.2nH, ±0.3nH	13	500	16	21	32	34	37	6500	0.39	230	0.30 ±0.03
HKQ0603S4N7□-T	RoHS	4.7	±0.2nH, ±0.3nH	13	500	16	21	32	34	37	6200	0.44	220	0.30 ±0.03
HKQ0603S5N1□-T	RoHS	5.1	±0.2nH, ±0.3nH	13	500	16	21	32	34	37	5900	0.49	210	0.30 ±0.03
HKQ0603S5N6□-T	RoHS	5.6	±0.2nH, ±0.3nH	13	500	16	21	32	34	37	5500	0.47	210	0.30 ±0.03
HKQ0603S6N2□-T	RoHS	6.2	±0.2nH, ±0.3nH	13	500	16	21	32	33	36	5100	0.52	200	0.30 ±0.03
HKQ0603S6N8□-T	RoHS	6.8	±3%, ±5%	13	500	16	21	31	32	35	4800	0.55	190	0.30 ±0.03
HKQ0603S7N5□-T	RoHS	7.5	±3%, ±5%	13	500	16	20	30	32	34	4600	0.51	200	0.30 ±0.03
HKQ0603S8N2□-T	RoHS	8.2	±3%, ±5%	13	500	16	20	30	31	33	4300	0.57	190	0.30 ±0.03
HKQ0603S9N1□-T	RoHS	9.1	±3%, ±5%	13	500	16	20	30	30	32	4000	0.73	170	0.30 ±0.03
HKQ0603S10N□-T	RoHS	10	±3%, ±5%	13	500	16	20	28	29	31	3800	0.85	160	0.30 ±0.03
HKQ0603S12N□-T	RoHS	12	±3%, ±5%	12	500	16	20	27	27	27	3300	0.85	160	0.30 ±0.03
HKQ0603S15N□-T	RoHS	15	±3%, ±5%	12	500	15	19	24	24	23	2600	0.89	150	0.30 ±0.03
HKQ0603S18N□-T	RoHS	18	±3%, ±5%	11	500	15	19	23	23	21	2300	1.05	140	0.30 ±0.03
HKQ0603S22N□-T	RoHS	22	±3%, ±5%	10	500	15	19	22	22	19	1900	1.29	130	0.30 ±0.03

*电感公差标在型号□中。

●HKQ603U

型号	EHS	标称电感值 [nH]	电感量公差	Q值 (min.)	LQ 测试频率 [MHz]	Q (Typical) 频率 [Hz]					自共振频率 [MHz] (min.)	直流电阻 DC [Ω] (max.)	额定电流 [mA] (max.)	厚度 [mm]
						500M	800M	1.8G	2.0G	2.4G				
HKQ603U0N6[-]T	RoHS	0.6	±0.1nH, ±0.2nH, ±0.3nH	14	500	>35	>47	>75	>80	>88	10000	0.06	900	0.30 ±0.03
HKQ603U0N7[-]T	RoHS	0.7	±0.1nH, ±0.2nH, ±0.3nH	14	500	>35	>47	>75	>80	>88	10000	0.06	900	0.30 ±0.03
HKQ603U0N8[-]T	RoHS	0.8	±0.1nH, ±0.2nH, ±0.3nH	14	500	>35	>47	>75	>80	>88	10000	0.06	900	0.30 ±0.03
HKQ603U0N9[-]T	RoHS	0.9	±0.1nH, ±0.2nH, ±0.3nH	14	500	>35	>47	>75	>80	>88	10000	0.06	900	0.30 ±0.03
HKQ603U1N0[-]T	RoHS	1.0	±0.1nH, ±0.2nH, ±0.3nH	14	500	>35	>47	>75	>80	>88	10000	0.07	850	0.30 ±0.03
HKQ603U1N1[-]T	RoHS	1.1	±0.1nH, ±0.2nH, ±0.3nH	14	500	>35	>47	>75	>80	>88	10000	0.07	850	0.30 ±0.03
HKQ603U1N2[-]T	RoHS	1.2	±0.1nH, ±0.2nH, ±0.3nH	14	500	35	47	75	80	88	10000	0.08	800	0.30 ±0.03
HKQ603U1N3[-]T	RoHS	1.3	±0.1nH, ±0.2nH, ±0.3nH	14	500	32	43	70	74	82	10000	0.09	760	0.30 ±0.03
HKQ603U1N4[-]T	RoHS	1.4	±0.1nH, ±0.2nH, ±0.3nH	14	500	29	39	63	67	75	10000	0.12	640	0.30 ±0.03
HKQ603U1N5[-]T	RoHS	1.5	±0.1nH, ±0.2nH, ±0.3nH	14	500	27	36	59	62	69	10000	0.15	600	0.30 ±0.03
HKQ603U1N6[-]T	RoHS	1.6	±0.1nH, ±0.2nH, ±0.3nH	14	500	25	33	54	57	63	10000	0.19	510	0.30 ±0.03
HKQ603U1N7[-]T	RoHS	1.7	±0.1nH, ±0.2nH, ±0.3nH	14	500	25	32	52	54	61	10000	0.11	680	0.30 ±0.03
HKQ603U1N8[-]T	RoHS	1.8	±0.1nH, ±0.2nH, ±0.3nH	14	500	25	32	51	53	59	10000	0.12	640	0.30 ±0.03
HKQ603U1N9[-]T	RoHS	1.9	±0.1nH, ±0.2nH, ±0.3nH	14	500	24	31	50	53	58	10000	0.13	620	0.30 ±0.03
HKQ603U2N0[-]T	RoHS	2.0	±0.1nH, ±0.2nH, ±0.3nH	14	500	24	31	50	53	58	10000	0.15	600	0.30 ±0.03
HKQ603U2N1[-]T	RoHS	2.1	±0.1nH, ±0.2nH, ±0.3nH	14	500	24	31	50	53	58	10000	0.16	550	0.30 ±0.03
HKQ603U2N2[-]T	RoHS	2.2	±0.1nH, ±0.2nH, ±0.3nH	14	500	24	31	50	53	58	10000	0.20	500	0.30 ±0.03
HKQ603U2N3[-]T	RoHS	2.3	±0.1nH, ±0.2nH, ±0.3nH	14	500	24	31	49	52	58	10000	0.24	460	0.30 ±0.03
HKQ603U2N4[-]T	RoHS	2.4	±0.1nH, ±0.2nH, ±0.3nH	14	500	22	28	45	48	53	10000	0.26	430	0.30 ±0.03
HKQ603U2N5[-]T	RoHS	2.5	±0.1nH, ±0.2nH, ±0.3nH	14	500	22	29	46	49	54	10000	0.28	415	0.30 ±0.03
HKQ603U2N6[-]T	RoHS	2.6	±0.1nH, ±0.2nH, ±0.3nH	14	500	21	27	44	46	51	10000	0.30	405	0.30 ±0.03
HKQ603U2N7[-]T	RoHS	2.7	±0.1nH, ±0.2nH, ±0.3nH	14	500	20	26	41	43	48	10000	0.32	400	0.30 ±0.03
HKQ603U2N8[-]T	RoHS	2.8	±0.1nH, ±0.2nH, ±0.3nH	14	500	20	26	41	43	47	9500	0.20	500	0.30 ±0.03
HKQ603U2N9[-]T	RoHS	2.9	±0.1nH, ±0.2nH, ±0.3nH	14	500	20	26	41	43	47	9300	0.22	480	0.30 ±0.03
HKQ603U3N0[-]T	RoHS	3.0	±0.1nH, ±0.2nH, ±0.3nH	14	500	20	26	41	43	47	9100	0.24	460	0.30 ±0.03
HKQ603U3N1[-]T	RoHS	3.1	±0.1nH, ±0.2nH, ±0.3nH	14	500	20	26	41	43	47	8900	0.25	450	0.30 ±0.03
HKQ603U3N2[-]T	RoHS	3.2	±0.1nH, ±0.2nH, ±0.3nH	14	500	20	26	40	43	47	8700	0.28	415	0.30 ±0.03
HKQ603U3N3[-]T	RoHS	3.3	±0.1nH, ±0.2nH, ±0.3nH	14	500	20	26	40	43	47	8600	0.28	415	0.30 ±0.03
HKQ603U3N4[-]T	RoHS	3.4	±0.1nH, ±0.2nH, ±0.3nH	14	500	20	25	40	43	47	8400	0.29	410	0.30 ±0.03
HKQ603U3N5[-]T	RoHS	3.5	±0.1nH, ±0.2nH, ±0.3nH	14	500	20	25	40	42	46	8200	0.30	405	0.30 ±0.03
HKQ603U3N6[-]T	RoHS	3.6	±0.1nH, ±0.2nH, ±0.3nH	14	500	19	25	40	42	46	8100	0.32	400	0.30 ±0.03
HKQ603U3N7[-]T	RoHS	3.7	±0.1nH, ±0.2nH, ±0.3nH	14	500	19	25	40	42	46	8000	0.36	370	0.30 ±0.03
HKQ603U3N8[-]T	RoHS	3.8	±0.1nH, ±0.2nH, ±0.3nH	14	500	19	25	39	41	45	7800	0.40	355	0.30 ±0.03
HKQ603U3N9[-]T	RoHS	3.9	±0.1nH, ±0.2nH, ±0.3nH	14	500	19	25	39	41	45	7700	0.41	350	0.30 ±0.03
HKQ603U4N0[-]T	RoHS	4.0	±0.1nH, ±0.2nH, ±0.3nH	14	500	18	25	39	41	45	7600	0.44	335	0.30 ±0.03
HKQ603U4N1[-]T	RoHS	4.1	±0.1nH, ±0.2nH, ±0.3nH	14	500	19	25	39	41	45	7500	0.48	320	0.30 ±0.03
HKQ603U4N2[-]T	RoHS	4.2	±0.1nH, ±0.2nH, ±0.3nH	14	500	18	24	37	39	43	7300	0.48	320	0.30 ±0.03
HKQ603U4N3[-]T	RoHS	4.3	±0.2nH, ±0.3nH	14	500	18	24	37	39	43	6500	0.48	320	0.30 ±0.03
HKQ603U4N6[-]T	RoHS	4.6	±0.2nH, ±0.3nH	14	500	18	24	37	39	42	6500	0.39	360	0.30 ±0.03
HKQ603U4N7[-]T	RoHS	4.7	±0.2nH, ±0.3nH	14	500	19	24	37	39	42	6400	0.42	350	0.30 ±0.03
HKQ603U5N0[-]T	RoHS	5.0	±0.2nH, ±0.3nH	14	500	19	24	37	39	42	6200	0.44	335	0.30 ±0.03
HKQ603U5N1[-]T	RoHS	5.1	±0.2nH, ±0.3nH	14	500	19	24	37	39	42	6100	0.45	330	0.30 ±0.03
HKQ603U5N4[-]T	RoHS	5.4	±0.2nH, ±0.3nH	14	500	18	24	36	38	42	5900	0.49	315	0.30 ±0.03
HKQ603U5N6[-]T	RoHS	5.6	±0.2nH, ±0.3nH	14	500	18	24	36	37	41	5500	0.47	325	0.30 ±0.03
HKQ603U5N9[-]T	RoHS	5.9	±0.2nH, ±0.3nH	14	500	18	23	35	36	39	5500	0.47	325	0.30 ±0.03
HKQ603U6N2[-]T	RoHS	6.2	±0.2nH, ±0.3nH	14	500	18	23	35	36	39	5100	0.52	305	0.30 ±0.03
HKQ603U6N5[-]T	RoHS	6.5	±0.2nH, ±0.3nH	14	500	18	23	35	36	39	5100	0.52	305	0.30 ±0.03
HKQ603U6N8[-]T	RoHS	6.8	±3%, ±5%	14	500	18	23	35	36	39	4800	0.55	305	0.30 ±0.03
HKQ603U7N1[-]T	RoHS	7.1	±3%, ±5%	14	500	18	23	35	36	39	4800	0.55	305	0.30 ±0.03
HKQ603U7N5[-]T	RoHS	7.5	±3%, ±5%	14	500	18	23	34	35	38	4600	0.55	305	0.30 ±0.03
HKQ603U7N8[-]T	RoHS	7.8	±3%, ±5%	14	500	17	22	33	34	36	4600	0.51	310	0.30 ±0.03
HKQ603U8N2[-]T	RoHS	8.2	±3%, ±5%	14	500	17	22	33	34	36	4300	0.57	290	0.30 ±0.03
HKQ603U8N5[-]T	RoHS	8.5	±3%, ±5%	14	500	17	22	33	34	36	4300	0.57	290	0.30 ±0.03
HKQ603U9N1[-]T	RoHS	9.1	±3%, ±5%	14	500	17	22	33	34	36	4000	0.65	270	0.30 ±0.03
HKQ603U9N4[-]T	RoHS	9.4	±3%, ±5%	14	500	17	22	33	34	36	4000	0.73	250	0.30 ±0.03
HKQ603U10N[-]T	RoHS	10	±3%, ±5%	14	500	17	22	33	34	36	3800	0.85	230	0.30 ±0.03
HKQ603U12N[-]T	RoHS	12	±3%, ±5%	14	500	17	22	31	32	33	3300	0.85	230	0.30 ±0.03
HKQ603U15N[-]T	RoHS	15	±3%, ±5%	14	500	17	21	28	29	29	2600	0.89	220	0.30 ±0.03
HKQ603U18N[-]T	RoHS	18	±3%, ±5%	14	500	16	21	26	26	25	2300	1.05	205	0.30 ±0.03
HKQ603U22N[-]T	RoHS	22	±3%, ±5%	14	500	16	21	26	26	24	1900	1.29	190	0.30 ±0.03

※电感值公差标在型号[-]中。

▶ 由于篇幅有限, 本产品目录中只记载了有代表性的产品规格。若考虑使用弊公司产品时, 请确认交货规格说明书中的详细规格。
另外, 有关各产品的详细信息(特性图、可靠性信息、使用时的注意事项等), 请参阅弊网站(<http://www.ty-top.com/>)。

● AQ 105

型号	EHS	标称电感值 [nH]	电感器公差 ※)	Q值 (min.)	LQ 测试频率 [MHz]	Q (Typical) 频率 [MHz]					自共振频率 [MHz]		直流电阻 DC [Ω]		额定电流 [mA] (max.)		厚度 [mm]
						300	800	900	1500	1800	(min.)	(typ.)	(max.)	(typ.)	-55~ +125°C	-55~ +85°C	
AQ 105 1N0□-T	RoHS	1.0	±0.3nH	8	100	53	129	147	217	244	10000	> 13000	0.07	0.014	710	930	0.50 ±0.05
AQ 105 1N2□-T	RoHS	1.2	±0.3nH	8	100	45	97	110	156	177	10000	> 13000	0.07	0.016	710	930	0.50 ±0.05
AQ 105 1N5□-T	RoHS	1.5	±0.3nH	8	100	35	69	76	104	116	8000	> 13000	0.07	0.030	710	930	0.50 ±0.05
AQ 105 1N8□-T	RoHS	1.8	±0.3nH	8	100	32	61	66	92	100	6000	11000	0.07	0.035	710	930	0.50 ±0.05
AQ 105 2N0□-T	RoHS	2.0	±0.3nH	8	100	38	68	73	94	103	6000	10500	0.08	0.035	660	870	0.50 ±0.05
AQ 105 2N2□-T	RoHS	2.2	±0.3nH	8	100	37	67	71	92	101	6000	10000	0.08	0.040	660	870	0.50 ±0.05
AQ 105 2N4□-T	RoHS	2.4	±0.3nH	8	100	34	54	59	74	86	6000	9600	0.09	0.050	630	820	0.50 ±0.05
AQ 105 2N7□-T	RoHS	2.7	±0.3nH	8	100	30	49	52	67	73	6000	9200	0.09	0.060	630	820	0.50 ±0.05
AQ 105 3N0□-T	RoHS	3.0	±0.3nH	8	100	31	51	54	70	76	6000	8700	0.11	0.070	570	740	0.50 ±0.05
AQ 105 3N3□-T	RoHS	3.3	±0.3nH	8	100	32	54	57	72	79	6000	8300	0.12	0.075	540	710	0.50 ±0.05
AQ 105 3N6□-T	RoHS	3.6	±0.3nH	8	100	33	53	56	71	77	5000	7800	0.14	0.080	500	650	0.50 ±0.05
AQ 105 3N9□-T	RoHS	3.9	±0.3nH	8	100	34	53	56	70	76	4000	7300	0.15	0.085	490	630	0.50 ±0.05
AQ 105 4N3□-T	RoHS	4.3	±0.3nH	8	100	29	47	50	64	71	4000	6900	0.16	0.090	470	610	0.50 ±0.05
AQ 105 4N7□-T	RoHS	4.7	±0.3nH	8	100	30	48	51	65	72	4000	6400	0.17	0.095	450	590	0.50 ±0.05
AQ 105 5N1□-T	RoHS	5.1	±0.3nH	8	100	30	48	51	64	71	4000	6300	0.19	0.110	430	560	0.50 ±0.05
AQ 105 5N6□-T	RoHS	5.6	±0.3nH	8	100	30	48	51	65	71	4000	6200	0.20	0.120	420	550	0.50 ±0.05
AQ 105 6N2□-T	RoHS	6.2	±0.3nH	8	100	31	49	52	66	72	3900	6100	0.22	0.130	400	520	0.50 ±0.05
AQ 105 6N8□-T	RoHS	6.8	±5%	8	100	28	44	49	59	64	3900	6000	0.23	0.130	390	510	0.50 ±0.05
AQ 105 7N5□-T	RoHS	7.5	±5%	8	100	28	45	50	60	65	3700	5500	0.25	0.135	370	490	0.50 ±0.05
AQ 105 8N2□-T	RoHS	8.2	±5%	8	100	29	46	50	62	66	3600	5000	0.27	0.140	360	470	0.50 ±0.05
AQ 105 9N1□-T	RoHS	9.1	±5%	8	100	29	45	49	59	62	3400	4800	0.29	0.150	350	450	0.50 ±0.05
AQ 105 10N□-T	RoHS	10	±5%	8	100	28	45	48	57	60	3200	4500	0.31	0.165	330	440	0.50 ±0.05
AQ 105 12N□-T	RoHS	12	±5%	8	100	26	40	45	51	52	2700	4300	0.39	0.165	300	390	0.50 ±0.05
AQ 105 15N□-T	RoHS	15	±5%	8	100	25	38	42	49	51	2300	4100	0.45	0.190	280	360	0.50 ±0.05

※电感器公差标在型号[]中。上述以外的电感器公差值，请另外咨询。

▶ 由于篇幅有限，本产品目录中只记载了有代表性的产品规格，若考虑使用弊公司产品时，请确认交货规格说明书中的详细规格。另外，有关各产品的详细信息(特性图、可靠性信息、使用时的注意事项等)，请参阅弊网站(<http://www.ty-top.com/>)。

Multilayer chip inductors

Multilayer chip inductors for high frequency, Multilayer chip bead inductors

Multilayer common mode choke coils (MC series F type)

Metal Multilayer Chip Power Inductors (MCOIL™ MC series)

PACKAGING

① Minimum Quantity

● Tape & Reel Packaging

Type	Thickness mm (inch)	Standard Quantity [pcs]	
		Paper Tape	Embossed Tape
CK1608(0603)	0.8 (0.031)	4000	—
CK2125(0805)	0.85(0.033)	4000	—
	1.25(0.049)	—	2000
CKS2125(0805)	0.85(0.033)	4000	—
	1.25(0.049)	—	2000
CKP1608(0603)	0.8 (0.031)	4000	—
CKP2012(0805)	0.9 (0.035)	—	3000
CKP2016(0806)	0.9 (0.035)	—	3000
CKP2520(1008)	0.7 (0.028)	—	3000
	0.9 (0.035)	—	3000
	1.1 (0.043)	—	2000
NM2012(0805)	0.9 (0.035)	—	3000
NM2520(1008)	0.9 (0.035)	—	3000
	1.1 (0.043)	—	2000
LK1005(0402)	0.5 (0.020)	10000	—
LK1608(0603)	0.8 (0.031)	4000	—
LK2125(0805)	0.85(0.033)	4000	—
	1.25(0.049)	—	2000
HK0603(0201)	0.3 (0.012)	15000	—
HK1005(0402)	0.5 (0.020)	10000	—
HK1608(0603)	0.8 (0.031)	4000	—
HK2125(0805)	0.85(0.033)	—	4000
	1.0 (0.039)	—	3000
HKQ0402(01005)	0.2 (0.008)	20000	40000
HKQ0603W(0201)	0.3 (0.012)	15000	—
HKQ0603C(0201)	0.3 (0.012)	15000	—
HKQ0603S(0201)	0.3 (0.012)	15000	—
HKQ0603U(0201)	0.3 (0.012)	15000	—
AQ105(0402)	0.5 (0.020)	10000	—
BK0402(01005)	0.2 (0.008)	20000	—
BK0603(0201)	0.3 (0.012)	15000	—
BK1005(0402)	0.5 (0.020)	10000	—
BKH0603(0201)	0.3 (0.012)	15000	—
BKH1005(0402)	0.5 (0.020)	10000	—
BK1608(0603)	0.8 (0.031)	4000	—
BK2125(0805)	0.85(0.033)	4000	—
	1.25(0.049)	—	2000
BK2010(0804)	0.45(0.018)	4000	—
BK3216(1206)	0.8 (0.031)	—	4000
BKP0402(01005)	0.2 (0.008)	20000	—
BKP0603(0201)	0.3 (0.012)	15000	—
BKP1005(0402)	0.5 (0.020)	10000	—
BKP1608(0603)	0.8 (0.031)	4000	—
BKP2125(0805)	0.85(0.033)	4000	—
MCF0605(0202)	0.3 (0.012)	15000	—
MCF0806(0302)	0.4 (0.016)	—	10000
MCF1210(0504)	0.55(0.022)	—	5000
MCF2010(0804)	0.45(0.018)	—	4000
MCFK1608(0603)	0.6 (0.024)	4000	—
MCFE1608(0603)	0.65(0.026)	4000	—
MCHK2012(0806)	0.8 (0.031)	4000	—
MCKK2012(0805)	1.0(0.039)	—	3000

▶ This catalog contains the typical specification only due to the limitation of space. When you consider the purchase of our products, please check our specification. For details of each product (characteristics graph, reliability information, precautions for use, and so on), see our Web site (<http://www.ty-top.com/>).

② Taping material

● Card board carrier tape

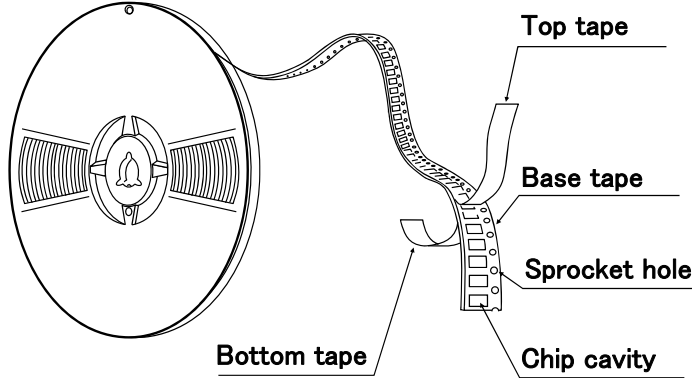

CK	1608
CKP	1608
CK	2125
CKS	2125
LK	1005
LK	1608
LK	2125
HK	0603
HK	1005
HK	1608
HKQ	0402
HKQ	0603
AQ	105

BK	0402
BK	0603
BK	1005
BK	1608
BK	2125
BK	2010
BKP	0402
BKP	0603
BKP	1005
BKP	1608
BKP	2125
BKH	0603
BKH	1005
MCF	0605
MC	1608
MC	2012



● Embossed Tape

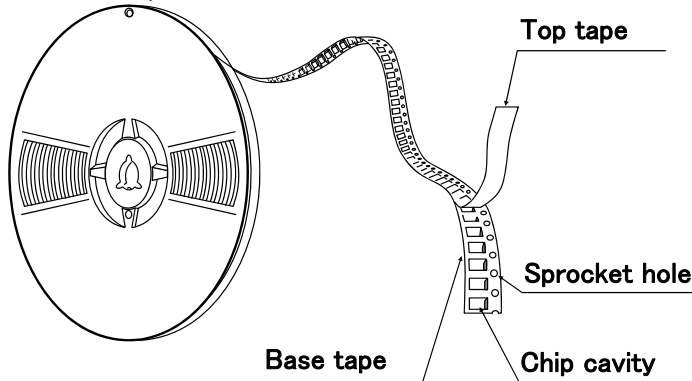

CK	2125
CKS	2125
CKP	2012
CKP	2016
CKP	2520
NM	2012
NM	2520
LK	2125
HKQ	0402
HK	2125

BK	2125
BK	3216
MCF	0806
MCF	1210
MCF	2010
MC	2012



③ Taping Dimensions

● Paper tape (8mm wide)

Unit: mm (inch)

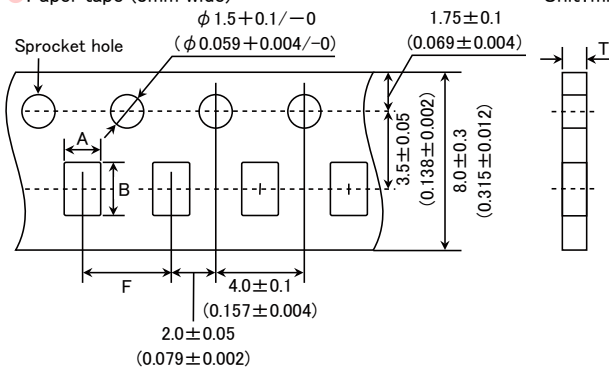

▶ This catalog contains the typical specification only due to the limitation of space. When you consider the purchase of our products, please check our specification. For details of each product (characteristics graph, reliability information, precautions for use, and so on), see our Web site (<http://www.ty-top.com/>).

Type	Thickness mm (inch)	Chip cavity		Insertion Pitch	Tape Thickness
		A	B	F	T
CK1608(0603)	0.8 (0.031)	1.0±0.2 (0.039±0.008)	1.8±0.2 (0.071±0.008)	4.0±0.1 (0.157±0.004)	1.1max (0.043max)
CK2125(0805)	0.85(0.033)	1.5±0.2 (0.059±0.008)	2.3±0.2 (0.091±0.008)	4.0±0.1 (0.157±0.004)	1.1max (0.043max)
CKS2125(0805)	0.85(0.033)	1.5±0.2 (0.059±0.008)	2.3±0.2 (0.091±0.008)	4.0±0.1 (0.157±0.004)	1.1max (0.043max)
CKP1608(0603)	0.8 (0.031)	1.0±0.2 (0.039±0.008)	1.8±0.2 (0.071±0.008)	4.0±0.1 (0.157±0.004)	1.1max (0.043max)
LK1005(0402)	0.5 (0.020)	0.65±0.1 (0.026±0.004)	1.15±0.1 (0.045±0.004)	2.0±0.05 (0.079±0.002)	0.8max (0.031max)
LK1608(0603)	0.8 (0.031)	1.0±0.2 (0.039±0.008)	1.8±0.2 (0.071±0.008)	4.0±0.1 (0.157±0.004)	1.1max (0.043max)
LK2125(0805)	0.85(0.033)	1.5±0.2 (0.059±0.008)	2.3±0.2 (0.091±0.008)	4.0±0.1 (0.157±0.004)	1.1max (0.043max)
HK0603(0201)	0.3 (0.012)	0.40±0.06 (0.016±0.002)	0.70±0.06 (0.028±0.002)	2.0±0.05 (0.079±0.002)	0.45max (0.018max)
HK1005(0402)	0.5 (0.020)	0.65±0.1 (0.026±0.004)	1.15±0.1 (0.045±0.004)	2.0±0.05 (0.079±0.002)	0.8max (0.031max)
HK1608(0603)	0.8 (0.031)	1.0±0.2 (0.039±0.008)	1.8±0.2 (0.071±0.008)	4.0±0.1 (0.157±0.004)	1.1max (0.043max)
HKQ0402(01005)	0.2 (0.008)	0.25±0.04 (0.010±0.002)	0.45±0.04 (0.018±0.002)	2.0±0.05 (0.079±0.002)	0.36max (0.014max)
HKQ0603W(0201)	0.3 (0.012)	0.40±0.06 (0.016±0.002)	0.70±0.06 (0.028±0.002)	2.0±0.05 (0.079±0.002)	0.45max (0.018max)
HKQ0603C(0201)	0.3 (0.012)	0.40±0.06 (0.016±0.002)	0.70±0.06 (0.028±0.002)	2.0±0.05 (0.079±0.002)	0.45max (0.018max)
HKQ0603S(0201)	0.3 (0.012)	0.40±0.06 (0.016±0.002)	0.70±0.06 (0.028±0.002)	2.0±0.05 (0.079±0.002)	0.45max (0.018max)
HKQ0603U(0201)	0.3 (0.012)	0.40±0.06 (0.016±0.002)	0.70±0.06 (0.028±0.002)	2.0±0.05 (0.079±0.002)	0.45max (0.018max)
AQ105(0402)	0.5 (0.020)	0.75±0.1 (0.030±0.004)	1.15±0.1 (0.045±0.004)	2.0±0.05 (0.079±0.002)	0.8max (0.031max)
BK0402(01005)	0.2 (0.008)	0.25±0.04 (0.010±0.002)	0.45±0.04 (0.018±0.002)	2.0±0.05 (0.079±0.002)	0.36max (0.014max)
BK0603(0201)	0.3 (0.012)	0.40±0.06 (0.016±0.002)	0.70±0.06 (0.028±0.002)	2.0±0.05 (0.079±0.002)	0.45max (0.018max)
BK1005(0402)	0.5 (0.020)	0.65±0.1 (0.026±0.004)	1.15±0.1 (0.045±0.004)	2.0±0.05 (0.079±0.002)	0.8max (0.031max)
BK1608(0603)	0.8 (0.031)	1.0±0.2 (0.039±0.008)	1.8±0.2 (0.071±0.008)	4.0±0.1 (0.157±0.004)	1.1max (0.043max)
BK2125(0805)	0.85(0.033)	1.5±0.2 (0.059±0.008)	2.3±0.2 (0.091±0.008)	4.0±0.1 (0.157±0.004)	1.1max (0.043max)
BK2010(0804)	0.45(0.018)	1.2±0.1 (0.047±0.004)	2.17±0.1 (0.085±0.004)	4.0±0.1 (0.157±0.004)	0.8max (0.031max)
BKP0402(01005)	0.2 (0.008)	0.25±0.04 (0.010±0.002)	0.45±0.04 (0.018±0.002)	2.0±0.05 (0.079±0.002)	0.36max (0.014max)
BKP0603(0201)	0.3 (0.012)	0.40±0.06 (0.016±0.002)	0.70±0.06 (0.028±0.002)	2.0±0.05 (0.079±0.002)	0.45max (0.018max)
BKP1005(0402)	0.5 (0.020)	0.65±0.1 (0.026±0.004)	1.15±0.1 (0.045±0.004)	2.0±0.05 (0.079±0.002)	0.8max (0.031max)
BKP1608(0603)	0.8 (0.031)	1.0±0.2 (0.039±0.008)	1.8±0.2 (0.071±0.008)	4.0±0.1 (0.157±0.004)	1.1max (0.043max)
BKP2125(0805)	0.85(0.033)	1.5±0.2 (0.059±0.008)	2.3±0.2 (0.091±0.008)	4.0±0.1 (0.157±0.004)	1.1max (0.043max)
BKH0603(0201)	0.3 (0.012)	0.40±0.06 (0.016±0.002)	0.70±0.06 (0.028±0.002)	2.0±0.05 (0.079±0.002)	0.45max (0.018max)
BKH1005(0402)	0.5 (0.020)	0.65±0.1 (0.026±0.004)	1.15±0.1 (0.045±0.004)	2.0±0.05 (0.079±0.002)	0.8max (0.031max)
MCF0605(0202)	0.3 (0.012)	0.62±0.03 (0.024±0.001)	0.77±0.03 (0.030±0.001)	2.0±0.05 (0.079±0.002)	0.45max (0.018max)
MCFK1608(0603)	0.6 (0.024)	1.1±0.05 (0.043±0.002)	1.9±0.05 (0.075±0.002)	4.0±0.1 (0.157±0.004)	0.72max (0.028max)
MCFE1608(0603)	0.65(0.026)	1.1±0.05 (0.043±0.002)	1.9±0.05 (0.075±0.002)	4.0±0.1 (0.157±0.004)	0.9max (0.035max)
MCHK2012(0805)	0.8 (0.031)	1.55±0.2 (0.061±0.008)	2.3±0.2 (0.091±0.008)	4.0±0.1 (0.157±0.004)	0.9max (0.035max)

Unit : mm (inch)

▶ This catalog contains the typical specification only due to the limitation of space. When you consider the purchase of our products, please check our specification.
For details of each product (characteristics graph, reliability information, precautions for use, and so on), see our Web site (<http://www.ty-top.com/>).

TAIYO YUDEN

i_mlci_pack_e-E05R01

● Embossed Tape (8mm wide)

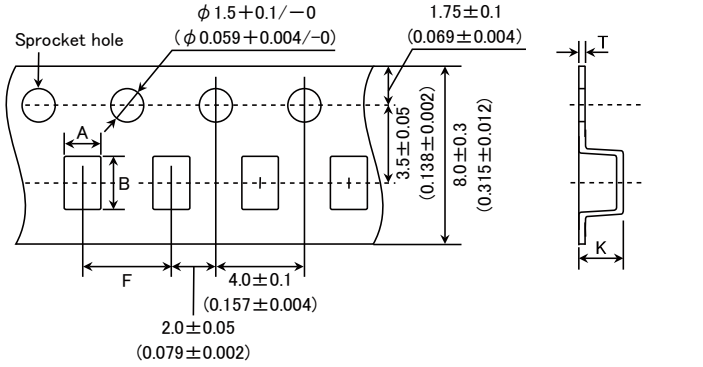

Type	Thickness mm (inch)	Chip cavity		Insertion Pitch F	Tape Thickness	
		A	B		K	T
CK2125 (0805)	1.25 (0.049)	1.5 ± 0.2 (0.059 ± 0.008)	2.3 ± 0.2 (0.091 ± 0.008)	4.0 ± 0.1 (0.157 ± 0.004)	2.0 (0.079)	0.3 (0.012)
CKS2125 (0805)	1.25 (0.049)	1.5 ± 0.2 (0.059 ± 0.008)	2.3 ± 0.2 (0.091 ± 0.008)	4.0 ± 0.1 (0.157 ± 0.004)	2.0 (0.079)	0.3 (0.012)
CKP2012 (0805)	0.9 (0.035)	1.55 ± 0.2 (0.061 ± 0.008)	2.3 ± 0.2 (0.091 ± 0.008)	4.0 ± 0.1 (0.157 ± 0.004)	1.3 (0.051)	0.3 (0.012)
CKP2016 (0806)	0.9 (0.035)	1.8 ± 0.1 (0.071 ± 0.004)	2.2 ± 0.1 (0.087 ± 0.004)	4.0 ± 0.1 (0.157 ± 0.004)	1.3 (0.051)	0.25 (0.01)
CKP2520 (1008)	0.7 (0.028)	2.3 ± 0.1 (0.091 ± 0.004)	2.8 ± 0.1 (0.110 ± 0.004)	4.0 ± 0.1 (0.157 ± 0.004)	1.4 (0.055)	0.3 (0.012)
	0.9 (0.035)				1.4 (0.055)	
	1.1 (0.043)				1.7 (0.067)	
NM2012 (0805)	0.9 (0.035)	1.55 ± 0.2 (0.061 ± 0.008)	2.3 ± 0.2 (0.091 ± 0.008)	4.0 ± 0.1 (0.157 ± 0.004)	1.3 (0.051)	0.3 (0.012)
NM2520 (1008)	0.9 (0.035)	2.3 ± 0.1 (0.091 ± 0.004)	2.8 ± 0.1 (0.110 ± 0.004)	4.0 ± 0.1 (0.157 ± 0.004)	1.4 (0.055)	0.3 (0.012)
	1.1 (0.043)				1.7 (0.067)	
LK2125 (0805)	1.25 (0.049)	1.5 ± 0.2 (0.059 ± 0.008)	2.3 ± 0.2 (0.091 ± 0.008)	4.0 ± 0.1 (0.157 ± 0.004)	2.0 (0.079)	0.3 (0.012)
HK2125 (0805)	0.85 (0.033)	1.5 ± 0.2 (0.059 ± 0.008)	2.3 ± 0.2 (0.091 ± 0.008)	4.0 ± 0.1 (0.157 ± 0.004)	1.5 (0.059)	0.3 (0.012)
	1.0 (0.039)				2.0 (0.079)	
BK2125 (0805)	1.25 (0.049)	1.5 ± 0.2 (0.059 ± 0.008)	2.3 ± 0.2 (0.091 ± 0.008)	4.0 ± 0.1 (0.157 ± 0.004)	2.0 (0.079)	0.3 (0.012)
BK3216 (1206)	0.8 (0.031)	1.9 ± 0.1 (0.075 ± 0.004)	3.5 ± 0.1 (0.138 ± 0.004)	4.0 ± 0.1 (0.157 ± 0.004)	1.4 (0.055)	0.3 (0.012)
MCF0806 (0302)	0.4 (0.016)	0.75 ± 0.05 (0.030 ± 0.002)	0.95 ± 0.05 (0.037 ± 0.002)	2.0 ± 0.05 (0.079 ± 0.002)	0.55 (0.022)	0.3 (0.012)
MCF1210 (0504)	0.55 (0.022)	1.15 ± 0.05 (0.045 ± 0.002)	1.40 ± 0.05 (0.055 ± 0.002)	4.0 ± 0.1 (0.157 ± 0.004)	0.65 (0.026)	0.3 (0.012)
MCF2010 (0804)	0.45 (0.018)	1.1 ± 0.1 (0.043 ± 0.004)	2.3 ± 0.1 (0.091 ± 0.004)	4.0 ± 0.1 (0.157 ± 0.004)	0.85 (0.033)	0.3 (0.012)
MCKK2012 (0805)	1.0 (0.039)	1.55 ± 0.2 (0.061 ± 0.008)	2.3 ± 0.2 (0.091 ± 0.008)	4.0 ± 0.1 (0.157 ± 0.004)	1.3 (0.051)	0.25 (0.010)

Unit : mm (inch)

● Embossed Tape (4mm wide)

Unit : mm (inch)

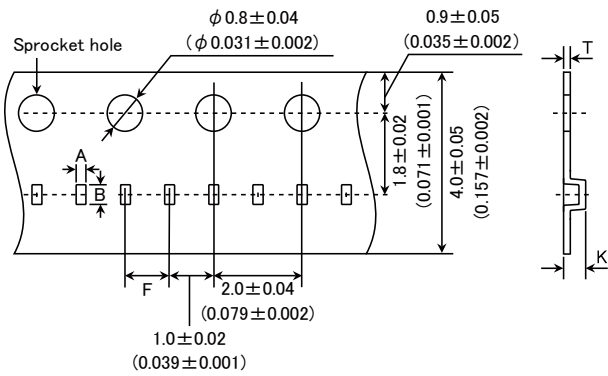

Type	Thickness mm (inch)	Chip cavity		Insertion Pitch F	Tape Thickness	
		A	B		K	T
HKQ0402 (01005)	0.2 (0.008)	0.23	0.43	1.0 ± 0.02	0.5max.	0.25max.

Unit : mm

④ LEADER AND BLANK PORTION

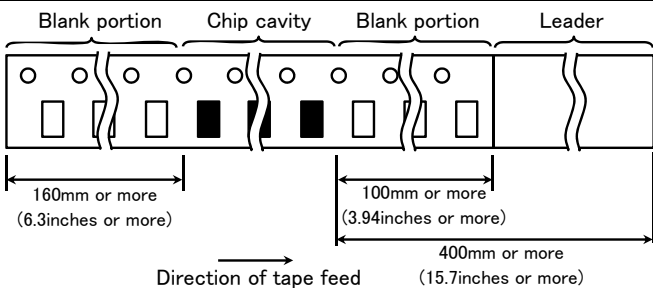

⑤ Reel Size

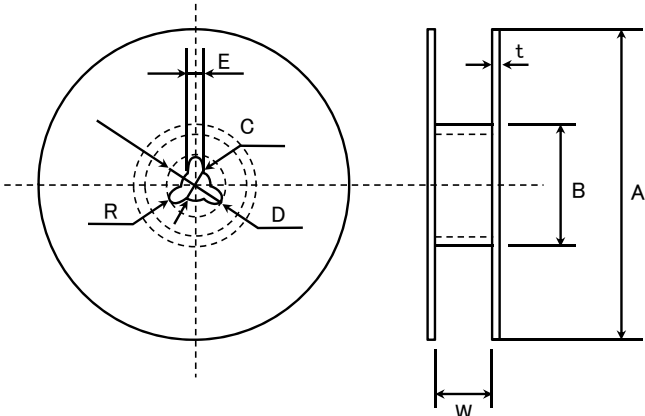

A	B	C	D	E	R
$\phi 178 \pm 2.0$	$\phi 50$ or more	$\phi 13.0 \pm 0.2$	$\phi 21.0 \pm 0.8$	2.0 ± 0.5	1.0

	t	W
4mm width tape	1.5max.	5 ± 1.0
8mm width tape	2.5max.	10 ± 1.5

(Unit : mm)

⑥ Top tape strength

The top tape requires a peel-off force of 0.1~0.7N in the direction of the arrow as illustrated below.

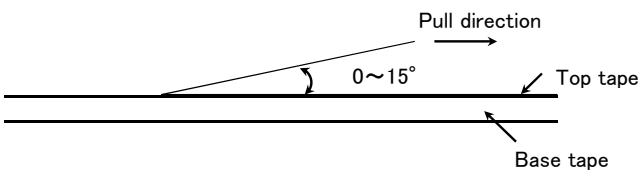

▶ This catalog contains the typical specification only due to the limitation of space. When you consider the purchase of our products, please check our specification. For details of each product (characteristics graph, reliability information, precautions for use, and so on), see our Web site (<http://www.ty-top.com/>).

Multilayer chip inductors

Multilayer chip inductors for high frequency, Multilayer chip bead inductors

Multilayer common mode choke coils (MC series F type)

Metal Multilayer Chip Power Inductors (MCOIL™ MC series)

RELIABILITY DATA

1. Operating Temperature Range			
Specified Value	BK0402	-55~+125°C	
	BK0603		
	BK1005		
	BKH0603		
	BKH1005		
	BK1608		
	BK2125		
	ARRAY		BK2010
			BK3216
	BKP0402		-55~+85°C
	BKP0603		
	BKP1005		
	BKP1608		
	BKP2125		
	MCF 0605	-40~+85°C	
	MCF 0806		
	MCF 1210		
	MCF 2010		
	CK1608	-40~+85°C	
	CK2125		
	CKS2125		
	CKP1608		
	CKP2012		
	CKP2016		
	CKP2520		
	NM2012		
	NM2520		
	LK1005		
	LK1608	-55~+125°C	
	LK2125		
	HKQ0402	-40~+85°C	
	HK0603		
HK1005			
HK1608	-55~+125°C		
HK2125			
HKQ0603W/HKQ0603C/HKQ0603S/ HKQ0603U/	-40~+125°C (Including self-generated heat)		
AQ105			
MCFK1608			
MCFE1608			
MCHK2012			
MCKK2012			

► This catalog contains the typical specification only due to the limitation of space. When you consider the purchase of our products, please check our specification.
For details of each product (characteristics graph, reliability information, precautions for use, and so on), see our Web site (<http://www.ty-top.com/>).

2. Storage Temperature Range

Specified Value	BK0402	-55~ +125°C	
	BK0603		
	BK1005		
	BKH0603		
	BKH1005		
	BK1608		
	BK2125		
	ARRAY		BK2010
			BK3216
	BKP0402		-55~ +85°C
	BKP0603		
	BKP1005		
	BKP1608		
	BKP2125		
	MCF 0605	-40~ +85°C	
	MCF 0806		
	MCF 1210		
	MCF 2010		
	CK1608	-40~ +85°C	
	CK2125		
	CKS2125		
	CKP1608		
	CKP2012		
	CKP2016		
	CKP2520		
NM2012			
NM2520			
LK1005			
LK1608	-55~ +125°C		
LK2125			
HKQ0402			
HK0603	-40~ +85°C		
HK1005			
HK1608	-55~ +125°C		
HK2125			
HKQ0603W/HKQ0603C/HKQ0603S/ HKQ0603U/			
AQ105	-40~ +85°C		
MCFK1608			
MCFE1608			
MCHK2012			
MCKK2012			

3. Rated Current

Specified Value	BK0402	150~750mA DC	
	BK0603	100~500mA DC	
	BK1005	120~1000mA DC	
	BKH0603	115~450mA DC	
	BKH1005	200~300mA DC	
	BK1608	150~1500mA DC	
	BK2125	200~1200mA DC	
	ARRAY	BK2010	100mA DC
		BK3216	100~200mA DC
	BKP0402	0.55~1.1A DC	
	BKP0603	0.8~1.8A DC	
	BKP1005	0.8~2.4A DC	
	BKP1608	1.0~3.0A DC	
	BKP2125	1.5~4.0A DC	
	MCF 0605	0.05A DC	
	MCF 0806	0.1~0.13A DC	
	MCF 1210	0.1~0.15A DC	
	MCF 2010	0.1A DC	
	CK1608	50~60mA DC	
	CK2125	60~500mA DC	
	CKS2125	110~280mA DC	
	CKP1608	0.35~0.9A DC	
	CKP2012	0.7~1.7A DC	
	CKP2016	0.9~1.6A DC	
	CKP2520	1.1~1.8A DC	
	NM2012	1.0~1.2A DC	
	NM2520	0.9~1.2A DC	
	LK1005	20~25mA DC	
	LK1608	1~150mA DC	
	LK2125	5~300mA DC	
	HK0603	60~470mA DC	
	HK1005	110~300mA DC (-55~+125°C) 200~900mA DC (-55~+85°C)	
	HK1608	150~300mA DC	
	HK2125	300mA DC	
	HKQ0402	100~500mA DC	
	HKQ0603W	100~850mA DC	
	HKQ0603C	160~850mA DC	
	HKQ0603S	130~600mA DC	
	HKQ0603U	190~900mA DC	
	AQ105	280~710mA DC	
	MCFK1608	Idc1 : 1900~2300mA DC, Idc2 : 1600~2100mA DC	
	MCFE1608	Idc1 : 1400~2600mA DC, Idc2 : 800~1500mA DC	
	MCHK2012	Idc1 : 3210~4320mA DC, Idc2 : 3240~3600mA DC	
	MCKK2012	Idc1 : 4500~6200mA DC, Idc2 : 3100~4000mA DC	

Definition of rated current:

- In the CK, CKS and BK Series, the rated current is the value of current at which the temperature of the element is increased within 20°C.
- In the BK Series P type, CK Series P type, NM Series, the rated current is the value of current at which the temperature of the element is increased within 40°C.
- In the LK, HK, HKQ0603, and AQ Series, the rated current is either the DC value at which the initial L value is decreased within 5% with the application of DC bias, or the value of current at which the temperature of the element is increased within 20°C.
- In the HKQ0402(~9N1), the rated current is either the DC value at which the initial L value is decreased within 5% with the application of DC bias, or the value of current at which the temperature of the element is increased within 20°C.
- In the HKQ0402(10N~), the rated current is either the DC value at which the initial L value is decreased within 5% with the application of DC bias, or the value of current at which the temperature of the element is increased within 25°C.
- In the MC Series, Idc1 is the DC value at which the initial L value is decreased within 30% and Idc2 is the DC value at which the temperature of element is increased within 40°C by the application of DC bias. (at 20°C)

4. Impedance

Specified Value	BK0402	10~330 Ω ±5 Ω 10 Ω, ±25%(Other)	
	BK0603	10~1200 Ω ±25%	
	BK1005	10~1800 Ω ±25%	
	BKH0603	25~1500 Ω ±25%	
	BKH1005	600~1800 Ω ±25%	
	BK1608	22~2500 Ω ±25%	
	BK2125	15~2500 Ω ±25%	
	ARRAY	BK2010	5~1000 Ω ±25%
		BK3216	60~1000 Ω ±25%
	BKP0402	10~33 Ω ±5 Ω 10 Ω, ±25%(Other)	
	BKP0603	10~120 Ω ±5 Ω 10 Ω, ±25%(Other)	
	BKP1005	10~330 Ω ±5 Ω(EM100), ±25%(Other)	
	BKP1608	33~470 Ω ±25%	
	BKP2125	33~330 Ω ±25%	
	MCF 0605	12~90 Ω ±5 Ω 12 Ω, ±20%(35 Ω), ±25%(Other)	
	MCF 0806	12~90 Ω ±5 Ω 12 Ω, ±20%(Other)	
	MCF 1210	40~90 Ω ±20%(2H900), ±25%(Other)	
	MCF 2010	90 Ω ±25%	
	CK1608		
	CK2125		
	CKS2125		
	CKP1608		
	CKP2012		
	CKP2016		
	CKP2520		
	NM2012		
	NM2520		
	LK1005		
	LK1608		
	LK2125		
	HKQ0402		
	HK0603		
HK1005			
HK1608			
HK2125			
HKQ0603W/HKQ0603C/HKQ0603S/ HKQ0603U			
AQ105			
MCFK1608			
MCFE1608			
MCHK2012			
MCKK2012			
Test Methods and Remarks	BK0402Series, BKP0402Series Measuring frequency : 100±1MHz Measuring equipment : E4991A (or its equivalent) Measuring jig : 16197A (or its equivalent)		
	BK0603Series, BKP0603Series Measuring frequency : 100±1MHz Measuring equipment : 4291A (or its equivalent) Measuring jig : 16193A (or its equivalent)		
	BK1005Series, BKP1005Series, BKH1005Series Measuring frequency : 100±1MHz Measuring equipment : 4291A (or its equivalent) Measuring jig : 16192A (or its equivalent), 16193A (or its equivalent)		
	BK1608・2125Series, BKP1608・2125Series Measuring frequency : 100±1MHz Measuring equipment : 4291A (or its equivalent), 4195A (or its equivalent) Measuring jig : 16092A (or its equivalent) or 16192A (or its equivalent) /HW		
	BK2010・3216Series, MCF Series Measuring frequency : 100±1MHz Measuring equipment : 4291A (or its equivalent), 4195A (or its equivalent) Measuring jig : 16192A (or its equivalent)		

► This catalog contains the typical specification only due to the limitation of space. When you consider the purchase of our products, please check our specification. For details of each product (characteristics graph, reliability information, precautions for use, and so on), see our Web site (<http://www.ty-top.com/>).

5. Inductance

Specified Value	BK0402		
	BK0603		
	BK1005		
	BKH0603		
	BKH1005		
	BK1608		
	BK2125		
	ARRAY	BK2010	
		BK3216	
	BKP0402		
	BKP0603		
	BKP1005		
	BKP1608		
	BKP2125		
	MCF 0605		
	MCF 0806		
	MCF 1210		
	MCF 2010		
	CK1608	4.7~10.0 μH: ±20%	
	CK2125	0.1~10.0 μH: ±20%	
	CKS2125	1.0~10.0 μH: ±20%	
	CKP1608	0.33~2.2 μH: ±20%	
	CKP2012	0.47~4.7 μH: ±20%	
	CKP2016	0.47~4.7 μH: ±20%	
	CKP2520	0.47~4.7 μH: ±20%	
	NM2012	0.82~1.0 μH: ±20%	
	NM2520	1.0~2.2 μH: ±20%	
	LK1005	0.12~2.2 μH: ±10 or 20%	
	LK1608	0.047~33.0 μH: ±20% 0.10~12.0 μH: ±10%	
	LK2125	0.047~33.0 μH: ±20% 0.10~12.0 μH: ±10%	
	HK0603	1.0~6.2nH: ±0.3nH 6.8~100nH: ±5%	
	HK1005	1.0~6.2nH: ±0.3nH 6.8~270nH: ±5%	
	HK1608	1.0~5.6nH: ±0.3nH 6.8~470nH: ±5%	
	HK2125	1.5~5.6nH: ±0.3nH 6.8~470nH: ±5%	
	HKQ0402	0.5~3.9nH: ±0.1 or 0.2 or 0.3nH 4.3~5.6nH: ±0.3nH or 3% or 5% 6.2~47nH: ±3 or 5%	
	HKQ0603W	0.6~3.9nH: ±0.1 or 0.2 or 0.3nH 4.3~6.2nH: ±0.2 or 0.3nH or 3 or 5% 6.8~30nH: ±3 or 5% 33~100nH: ±5%	
	HKQ0603C	0.6~3.9nH: ±0.1 or 0.2 or 0.3nH 4.3~6.2nH: ±0.2 or 0.3nH 6.8~22nH: ±3 or 5%	
	HKQ0603S	0.6~6.2nH: ±0.2 or 0.3nH 6.8~22nH: ±3 or 5%	
	HKQ0603U	0.6~4.2nH: ±0.1 or 0.2 or 0.3nH 4.3~6.5nH: ±0.2 or 0.3nH 6.8~22nH: ±3 or 5%	
	AQ105	1.0~6.2nH: ±0.3nH 6.8~15nH: ±5%	
	MCFK1608	0.24~0.47H: ±20%	
	MCFE1608	0.24~1.0 μH: ±20%	
	MCHK2012	0.24~0.47H: ±20%	
	MCKK2012	0.24~0.47H: ±20%	
	Test Methods and Remarks	CK, LK, CKP, NM, MC Series	
		Measuring frequency	: 2~4MHz (CK1608)
		Measuring frequency	: 2~25MHz (CK2125)
		Measuring frequency	: 2~10MHz (CKS2125)
		Measuring frequency	: 10~25MHz (LK1005)
		Measuring frequency	: 1~50MHz (LK1608)
		Measuring frequency	: 0.4~50MHz (LK2125)
		Measuring frequency	: 1MHz (CKP1608・CKP2012・CKP2016・CKP2520・NM2012・NM2520・MCFK1608・MCFE1608・MCHK2012・MCKK2012)
		Measuring equipment /jig	・4194A + 16085B + 16092A (or its equivalent) ・4195A + 41951 + 16092A (or its equivalent) ・4294A + 16192A (or its equivalent) ・4291A + 16193A (or its equivalent) /LK1005 ・4285A + 42841A + 42842C + 42851 - 61100 (or its equivalent) /CKP1608・CKP2012・CKP2016・CKP2520・NM2012・NM2520・MCFK1608・MCFE1608・MCHK2012・MCKK2012
		Measuring current	・1mA rms (0.047~4.7 μH) ・0.1mA rms (5.6~33 μH)
		HK, HKQ, AQ Series	
		Measuring frequency	: 100MHz (HK0603・HK1005・AQ105)
		Measuring frequency	: 50/100MHz (HK1608・HK2125)
Measuring frequency		: 500MHz (HKQ0603C・HKQ0603S・HKQ0603U)	
Measuring frequency		: 300/500MHz (HKQ0603W)	
Measuring frequency		: 100/500MHz (HKQ0402)	
Measuring equipment /jig		・4291A + 16197A (or its equivalent) /HK0603・AQ105 ・4291A + 16193A (or its equivalent) /HK1005 ・E4991A + 16197A (or its equivalent) /HKQ0603S・HKQ0603U・HKQ0603W・HKQ0603C ・4291A + 16092A + in-house made jig (or its equivalent) /HK1608・HK2125 ・E4991A + 16196D (or its equivalent) /HKQ0402	

Specified Value	BK0402	—	
	BK0603		
	BK1005		
	BKH0603		
	BKH1005		
	BK1608		
	BK2125		
	ARRAY		BK2010
			BK3216
	BKP0402		
	BKP0603		
	BKP1005		
	BKP1608		
	BKP2125		
	MCF 0605		
	MCF 0806		
	MCF 1210		
	MCF 2010		
	CK1608		—
	CK2125		
	CKS2125		
	CKP1608		
	CKP2012		
	CKP2016		
	CKP2520		
NM2012			
NM2520			
LK1005	10~20 min.		
LK1608	10~35 min.		
LK2125	15~50 min.		
HK0603	4~5 min.		
HK1005	8 min.		
HK1608	8~12 min.		
HK2125	10~18 min.		
HKQ0402	3~8 min.		
HKQ0603W	6~15 min.		
HKQ0603C	14~15 min.		
HKQ0603S	10~13 min.		
HKQ0603U	14 min.		
AQ105	8 min.		
MCFK1608	—		
MCFE1608			
MCHK2012			
MCKK2012			
Test Methods and Remarks	LK Series		
	Measuring frequency	: 10~25MHz(LK1005)	
	Measuring frequency	: 1~50MHz(LK1608)	
	Measuring frequency	: 0.4~50MHz(LK2125)	
	Measuring equipment /jig	·4194A+16085B+16092A(or its equivalent) ·4195A+41951+16092A(or its equivalent) ·4294A+16192A(or its equivalent) ·4291A+16193A(or its equivalent)/LK1005	
	Measuring current	·1mA rms(0.047~4.7 μH) ·0.1mA rms(5.6~33 μH)	
	HK、HKQ、AQ Series		
	Measuring frequency	: 100MHz(HK0603·HK1005·AQ105)	
	Measuring frequency	: 50/100MHz(HK1608·HK2125)	
	Measuring frequency	: 500MHz(HKQ0603C·HKQ0603S·HKQ0603U)	
	Measuring frequency	: 300/500MHz(HKQ0603W)	
	Measuring frequency	: 100/500MHz(HKQ0402)	
	Measuring equipment /jig	·4291A+16197A(or its equivalent)/HK0603·AQ105 ·4291A+16193A(or its equivalent)/HK1005 ·E4991A+16197A(or its equivalent)/HKQ0603S·HKQ0603U·HKQ0603W·HKQ0603C ·4291A+16092A + in-house made jig(or its equivalent)/HK1608, HK2125 ·E4991A+16196D(or its equivalent)HKQ0402	

7. DC Resistance

Specified Value	BK0402	0.07~1.2 Ω max.	
	BK0603	0.065~1.50 Ω max.	
	BK1005	0.03~0.90 Ω max.	
	BKH0603	0.26~3.20 Ω max.	
	BKH1005	0.85~2.00 Ω max.	
	BK1608	0.05~1.10 Ω max.	
	BK2125	0.05~0.75 Ω max.	
	ARRAY	BK2010	0.10~0.90 Ω max.
		BK3216	0.15~0.80 Ω max.
	BKP0402	0.05~0.15 Ω max.	
	BKP0603	0.030~0.180 Ω max.	
	BKP1005	0.0273~0.220 Ω max.	
	BKP1608	0.025~0.18 Ω max.	
	BKP2125	0.020~0.075 Ω max.	
	MCF 0605	2.5~6.5 Ω max	
	MCF 0806	2.5~5.0 Ω max.	
	MCF 1210	2.5~4.5 Ω max.	
	MCF 2010	4.5 Ω max.	
	CK1608	0.45~0.85 Ω(±30%)	
	CK2125	0.16~0.65 Ω max.	
	CKS2125	0.12~0.52 Ω max.	
	CKP1608	0.15~0.35 Ω max.	
	CKP2012	0.08~0.28 Ω max.	
	CKP2016	0.075~0.20 Ω max	
	CKP2520	0.05~0.16 Ω max.	
	NM2012	0.10~0.15 Ω max.	
	NM2520	0.11~0.22 Ω max.	
	LK1005	0.41~1.16 Ω max.	
	LK1608	0.2~2.2 Ω max.	
	LK2125	0.1~1.1 Ω max.	
	HK0603	0.11~3.74 Ω max.	
	HK1005	0.08~4.8 Ω max.	
	HK1608	0.05~2.6 Ω max.	
	HK2125	0.10~1.5 Ω max.	
	HKQ0402	0.08~5.0 Ω max.	
HKQ0603W	0.07~4.1 Ω max.		
HKQ0603C	0.07~1.6 Ω max.		
HKQ0603S	0.06~1.29 Ω max.		
HKQ0603U	0.06~1.29 Ω max.		
AQ105	0.07~0.45 Ω max.		
MCFK1608	0.050~0.085 Ω max.		
MCFE1608	0.100~0.340 Ω max.		
MCHK2012	0.024~0.036 Ω max.		
MCKK2012	0.025~0.039 Ω max.		
Test Methods and Remarks	Measuring equipment: VOAC-7412, VOAC-7512, VOAC-7521 (made by Iwasaki Tsushinki), HIOKI3227 (or its equivalent)		

8. Self Resonance Frequency (SRF)		
Specified Value	BK0402	
	BK0603	
	BK1005	
	BKH0603	
	BKH1005	
	BK1608	
	BK2125	
	ARRAY	BK2010
		BK3216
	BKP0402	—
	BKP0603	
	BKP1005	
	BKP1608	
	BKP2125	
	MCF 0605	
	MCF 0806	
	MCF 1210	
	MCF 2010	
	CK1608	17~25MHz min.
	CK2125	24~235MHz min.
	CKS2125	24~75MHz min.
	CKP1608	
	CKP2012	—
	CKP2016	
	CKP2520	
	NM2012	
	NM2520	
	LK1005	40~180MHz min.
	LK1608	9~260MHz min.
	LK2125	13~320MHz min.
	HK0603	900~10000MHz min.
	HK1005	400~10000MHz min.
	HK1608	300~10000MHz min.
	HK2125	200~4000MHz min.
	HKQ0402	1200~10000MHz min.
HKQ0603W	800~10000MHz min.	
HKQ0603C	2500~10000MHz min.	
HKQ0603S	1900~10000MHz min.	
HKQ0603U	1900~10000MHz min.	
AQ105	2300~10000MHz min.	
MCFK1608		
MCFE1608	—	
MCHK2012		
MCKK2012		
Test Methods and Remarks	LK, CK Series : Measuring equipment : 4195A (or its equivalent) Measuring jig : 41951 + 16092A (or its equivalent) HK, HKQ, AQ Series : Measuring equipment : 8719C (or its equivalent) • 8753D (or its equivalent) / HK2125	

▶ This catalog contains the typical specification only due to the limitation of space. When you consider the purchase of our products, please check our specification.
 For details of each product (characteristics graph, reliability information, precautions for use, and so on), see our Web site (<http://www.ty-top.com/>).

9. Temperature Characteristic

Specified Value	BK0402	-	
	BK0603		
	BK1005		
	BKH0603		
	BKH1005		
	BK1608		
	BK2125		
	ARRAY		BK2010
			BK3216
	BKP0402		
	BKP0603		
	BKP1005		
	BKP1608		
	BKP2125		
	MCF 0605		
	MCF 0806		
	MCF 1210		
	MCF 2010		
	CK1608		
	CK2125		
	CKS2125		
	CKP1608		
	CKP2012		
	CKP2016		
	CKP2520		
	NM2012		
	NM2520		
	LK1005		
	LK1608		
	LK2125		
	HK0603		Inductance change: Within $\pm 10\%$
	HK1005		
	HK1608		
	HK2125		
	HKQ0402		
HKQ0603W			
HKQ0603C			
HKQ0603S			
HKQ0603U			
AQ105			
MCFK1608			
MCFE1608			
MCHK2012			
MCKK2012			
Test Methods and Remarks	HK, HKQ, AQ Series:		
	Temperature range : $-30 \sim +85^{\circ}\text{C}$		
	Reference temperature : $+20^{\circ}\text{C}$		
	MC Series:		
Temperature range : $-40 \sim +85^{\circ}\text{C}$			
Reference temperature : $+20^{\circ}\text{C}$			

10. Resistance to Flexure of Substrate

Specified Value	BK0402	No mechanical damage.	
	BK0603		
	BK1005		
	BKH0603		
	BKH1005		
	BK1608		
	BK2125		
	ARRAY		BK2010
			BK3216
	BKP0402		
	BKP0603		
	BKP1005		
	BKP1608		
	BKP2125		
	MCF 0605		
	MCF 0806		
	MCF 1210		
	MCF 2010		
	CK1608		
	CK2125		
	CKS2125		
	CKP1608		
	CKP2012		
	CKP2016		
	CKP2520		
	NM2012		
	NM2520		
	LK1005		
	LK1608		
	LK2125		
	HK0603		
	HK1005		
	HK1608		
	HK2125		
	HKQ0402		
	HKQ0603W		
	HKQ0603C		
	HKQ0603S		
	HKQ0603U		
	AQ105		
	MCFK1608		
	MCFE1608		
	MCHK2012		
	MCKK2012		

Test Methods and Remarks	<p>Warp : 2mm (BK Series without 0402size, BKP, BKH1005, CK, CKS, CKP, LK, HK, HKQ0603S, HKQ0603U, AQ Series, MCF1210, MC Series)</p> <p>: 1mm (BK0402, BKP0402, BKH0603, HKQ0402, HKQ0603W, HKQ0603C Series, MCF Series without 1210 size,)</p> <p>Testing board : glass epoxy-resin substrate</p> <p>Thickness : 0.8mm</p>
	<p>(Unit: mm)</p>

► This catalog contains the typical specification only due to the limitation of space. When you consider the purchase of our products, please check our specification. For details of each product (characteristics graph, reliability information, precautions for use, and so on), see our Web site (<http://www.ty-top.com/>).

11. Solderability

Specified Value	BK0402	At least 75% of terminal electrode is covered by new solder.	
	BK0603		
	BK1005		
	BKH0603		
	BKH1005		
	BK1608		
	BK2125		
	ARRAY		BK2010
			BK3216
	BKP0402		
	BKP0603		
	BKP1005		
	BKP1608		
	BKP2125		
	MCF 0605		
	MCF 0806		
	MCF 1210		
	MCF 2010		
	CK1608		
	CK2125		
	CKS2125		
	CKP1608		
	CKP2012		
	CKP2016		
	CKP2520		
	NM2012		
	NM2520		
	LK1005		
	LK1608		
	LK2125		
	HK0603		
	HK1005		
	HK1608		
	HK2125		
	HKQ0402		
HKQ0603W			
HKQ0603C			
HKQ0603S			
HKQ0603U			
AQ105			
MCFK1608			
MCFE1608			
MCHK2012			
MCKK2012			
Test Methods and Remarks	Solder temperature : 230±5°C (JIS Z 3282 H60A or H63A)		
	Solder temperature : 245±3°C (Sn/3.0Ag/0.5Cu)		
	Duration : 4±1 sec.		

▶ This catalog contains the typical specification only due to the limitation of space. When you consider the purchase of our products, please check our specification.
 For details of each product (characteristics graph, reliability information, precautions for use, and so on), see our Web site (<http://www.ty-top.com/>).

12. Resistance to Soldering

Specified Value	BK0402	Appearance: No significant abnormality Impedance change: Within $\pm 30\%$	
	BK0603		
	BK1005		
	BKH0603		
	BKH1005		
	BK1608		
	BK2125		
	ARRAY		BK2010
			BK3216
	BKP0402		
	BKP0603		
	BKP1005		
	BKP1608		
	BKP2125		
	MCF 0605		Appearance: No significant abnormality Impedance change: Within $\pm 20\%$
	MCF 0806		
	MCF 1210		
	MCF 2010		
	CK1608	No mechanical damage. Remaining terminal electrode: 70% min	
	CK2125		
	CKS2125	Inductance change R10~4R7: Within $\pm 10\%$ 6R8~100: Within $\pm 15\%$ CKS2125 : Within $\pm 20\%$ CKP1608, CKP2012, CKP2016, CKP2520, NM2012, NM2520: Within $\pm 30\%$	
	CKP1608		
	CKP2012		
	CKP2016		
	CKP2520		
	NM2012		
	NM2520		
	LK1005	No mechanical damage. Remaining terminal electrode: 70% min. Inductance change: Within $\pm 15\%$	
	LK1608	No mechanical damage. Remaining terminal electrode: 70% min. Inductance change 47N~4R7: Within $\pm 10\%$ 5R6~330: Within $\pm 15\%$	
	LK2125		
	HK0603	No mechanical damage. Remaining terminal electrode: 70% min. Inductance change: Within $\pm 5\%$	
	HK1005		
	HK1608		
	HK2125		
	HKQ0402		
	HKQ0603W		
HKQ0603C			
HKQ0603S			
HKQ0603U			
AQ105			
MCFK1608	No mechanical damage. Remaining terminal electrode: 70% min. Inductance change: Within $\pm 10\%$		
MCFE1608			
MCHK2012			
MCKK2012			
Test Methods and Remarks	Solder temperature : $260 \pm 5^\circ\text{C}$ Duration : 10 ± 0.5 sec. Preheating temperature : 150 to 180°C Preheating time : 3 min. Flux : Immersion into methanol solution with colophony for 3 to 5 sec. Recovery : 2 to 3 hrs of recovery under the standard condition after the test. (See Note 1)		

(Note 1) When there are questions concerning measurement result; measurement shall be made after 48 ± 2 hrs of recovery under the standard condition.

13. Thermal Shock

Specified Value	BK0402	Appearance: No significant abnormality Impedance change: Within $\pm 30\%$	
	BK0603		
	BK1005		
	BKH0603		
	BKH1005		
	BK1608		
	BK2125		
	ARRAY		BK2010
			BK3216
	BKP0402		
	BKP0603		
	BKP1005		
	BKP1608		
	BKP2125		
	MCF 0605		Appearance: No significant abnormality Impedance change: Within $\pm 20\%$
	MCF 0806		
	MCF 1210		
	MCF 2010		
	CK1608	No mechanical damage. Inductance change: Within $\pm 20\%$ Q change: Within $\pm 30\%$	
	CK2125		
	CKS2125		
	CKP1608	No mechanical damage. Inductance change: Within $\pm 30\%$	
	CKP2012		
	CKP2016		
	CKP2520		
	NM2012		
	NM2520	No mechanical damage. Inductance change: Within $\pm 10\%$ Q change: Within $\pm 30\%$	
	LK1005		
	LK1608		
	LK2125		
	HK0603	No mechanical damage. Inductance change: Within $\pm 10\%$ Q change: Within $\pm 20\%$	
	HK1005		
	HK1608		
HK2125			
HKQ0402			
HKQ0603W			
HKQ0603C			
HKQ0603S			
HKQ0603U			
AQ105			
MCFK1608	Appearance: No significant abnormality Inductance change: Within $\pm 10\%$		
MCFE1608			
MCHK2012			
MCKK2012			
Test Methods and Remarks	Conditions for 1 cycle		
	Step	temperature (°C)	time (min.)
	1	Minimum operating temperature +0/−3	30±3
	2	Room temperature	2~3
	3	Maximum operating temperature +3/−0	30±3
4	Room temperature	2~3	
	Number of cycles: 5		
	Recovery: 2 to 3 hrs of recovery under the standard condition after the test. (See Note 1)		
(Note 1) When there are questions concerning measurement result; measurement shall be made after 48±2 hrs of recovery under the standard condition.			

14. Damp Heat (Steady state)			
Specified Value	BK0402	Appearance: No significant abnormality Impedance change: Within $\pm 30\%$	
	BK0603		
	BK1005		
	BKH0603		
	BKH1005		
	BK1608		
	BK2125		
	ARRAY		BK2010
			BK3216
	BKP0402		
	BKP0603		
	BKP1005		
	BKP1608		
	BKP2125		
	MCF 0605		Appearance: No significant abnormality Impedance change: Within $\pm 20\%$
	MCF 0806		
	MCF 1210		
	MCF 2010		
	CK1608	No mechanical damage.	
	CK2125	Inductance change: Within $\pm 20\%$ Q change: Within $\pm 30\%$	
	CKS2125	Inductance change: Within $\pm 20\%$	
	CKP1608	No mechanical damage. Inductance change: Within $\pm 30\%$	
	CKP2012		
	CKP2016		
	CKP2520		
	NM2012		
	NM2520		
	LK1005	No mechanical damage.	
	LK1608	Inductance change: Within $\pm 10\%$ Q change: Within $\pm 30\%$	
	LK2125	No mechanical damage. Inductance change: Within $\pm 20\%$ Q change: Within $\pm 30\%$	
	HK0603	No mechanical damage. Inductance change: Within $\pm 10\%$ Q change: Within $\pm 20\%$	
	HK1005		
HK1608			
HK2125			
HKQ0402			
HKQ0603W			
HKQ0603C			
HKQ0603S			
HKQ0603U			
AQ105			
MCFK1608	Appearance: No significant abnormality Inductance change: Within $\pm 10\%$		
MCFE1608			
MCHK2012			
MCKK2012			
Test Methods and Remarks	BK, BKP, BKH Series, MCF Series: Temperature : $40 \pm 2^\circ\text{C}$ Humidity : 90 to 95%RH Duration : 500+24/-0 hrs Recovery : 2 to 3 hrs of recovery under the standard condition after the removal from test chamber. (See Note 1)		
	LK, CK, CKS, CKP, NM, HK, HKQ, AQ, MC Series: Temperature : $40 \pm 2^\circ\text{C}$ (LK, CK, CKS, CKP Series) : $60 \pm 2^\circ\text{C}$ (HK, HKQ, AQ, MC Series) Humidity : 90 to 95%RH Duration : 500 \pm 12 hrs Recovery : 2 to 3 hrs of recovery under the standard condition after the removal from test chamber. (See Note 1)		
	(Note 1) When there are questions concerning measurement result; measurement shall be made after 48 ± 2 hrs of recovery under the standard condition.		

15. Loading under Damp Heat

Specified Value	BK0402	Appearance: No significant abnormality Impedance change: Within $\pm 30\%$				
	BK0603					
	BK1005					
	BKH0603		No mechanical damage. Inductance change: Within $\pm 20\%$ Q change: Within $\pm 30\%$			
	BKH1005					
	BK1608					
	BK2125					
	ARRAY			BK2010		
				BK3216		
	BKP0402			No mechanical damage. Inductance change: Within $\pm 20\%$ Q change: Within $\pm 30\%$		
	BKP0603					
	BKP1005					
	BKP1608					
	BKP2125					
	CK1608				No mechanical damage. Inductance change: Within $\pm 30\%$	
	CK2125					
	CKS2125					
	CKP1608					
	CKP2012					
	CKP2016					
	CKP2520					
	NM2012					
	NM2520					
	LK1005					No mechanical damage. Inductance change: Within $\pm 10\%$ Q change: Within $\pm 30\%$
	LK1608					
	LK2125					
	HK0603					
	HK1005					
	HK1608					
	HK2125					
	HKQ0402					
	HKQ0603W					
HKQ0603C						
HKQ0603S						
HKQ0603U						
AQ105						
MCFK1608※	Appearance: No significant abnormality Inductance change: Within $\pm 10\%$					
MCFE1608※						
MCHK2012※						
MCKK2012※						

Test Methods and Remarks

BK, BKP, BKH Series:
 Temperature : $40 \pm 2^\circ\text{C}$
 Humidity : 90 to 95%RH
 Applied current : Rated current
 Duration : 500 + 24 / - 0 hrs
 Recovery : 2 to 3 hrs of recovery under the standard condition after the removal from test chamber. (See Note 1)

LK, CK, CKS, CKP, NM, HK, HKQ, AQ, MC Series:
 Temperature : $40 \pm 2^\circ\text{C}$ (LK, CK, CKS, CKP, NM Series)
 : $60 \pm 2^\circ\text{C}$ (HK, HKQ, AQ, MC Series)
 Humidity : 90 to 95%RH
 Applied current : Rated current ※MC series ; I_{dc2max}
 Duration : 500 \pm 12 hrs
 Recovery : 2 to 3 hrs of recovery under the standard condition after the removal from test chamber. (See Note 1)

Note on standard condition: "standard condition" referred to herein is defined as follows:

5 to 35°C of temperature, 45 to 85% relative humidity, and 86 to 106kPa of air pressure.

When there are questions concerning measurement results:

In order to provide correlation data, the test shall be conducted under condition of $20 \pm 2^\circ\text{C}$ of temperature, 60 to 70% relative humidity, and 86 to 106kPa of air pressure.

Unless otherwise specified, all the tests are conducted under the "standard condition."

(Note 1) Measurement shall be made after 48 ± 2 hrs of recovery under the standard condition.

16. Loading at High Temperature

Specified Value	BK0402	Appearance: No significant abnormality Impedance change: Within $\pm 30\%$	
	BK0603		
	BK1005		
	BKH0603		
	BKH1005		
	BK1608		
	BK2125		
	ARRAY		BK2010
			BK3216
	BKP0402		
	BKP0603		
	BKP1005		
	BKP1608		
	BKP2125		
	MCF 0605		Appearance: No significant abnormality Impedance change: Within $\pm 20\%$
	MCF 0806		
	MCF 1210		
	MCF 2010		
	CK1608	No mechanical damage.	
	CK2125	Inductance change: Within $\pm 20\%$ Q change: Within $\pm 30\%$	
	CKS2125	No mechanical damage. Inductance change: Within $\pm 20\%$	
	CKP1608	No mechanical damage. Inductance change: Within $\pm 30\%$	
	CKP2012		
	CKP2016		
	CKP2520		
	NM2012		
	NM2520		
	LK1005	No mechanical damage. Inductance change: Within $\pm 10\%$ Q change: Within $\pm 30\%$	
	LK1608	No mechanical damage. Inductance change: $0.047 \sim 12.0 \mu\text{H}$: Within $\pm 10\%$ $15.0 \sim 33.0 \mu\text{H}$: Within $\pm 15\%$ Q change: Within $\pm 30\%$	
	LK2125	No mechanical damage. Inductance change: Within $\pm 20\%$ Q change: Within $\pm 30\%$	
	HK0603	No mechanical damage. Inductance change: Within $\pm 10\%$ Q change: Within $\pm 20\%$	
	HK1005		
	HK1608		
	HK2125		
	HKQ0402		
HKQ0603W			
HKQ0603C			
HKQ0603S			
HKQ0603U			
AQ105			
MCFK1608※			
MCFE1608※	Appearance: No significant abnormality Inductance change: Within $\pm 10\%$		
MCHK2012※			
MCKK2012※			

Test Methods and Remarks	<p>BK, BKH, BKP Series, MCF Series:</p> <p>Temperature : $125 \pm 3^\circ\text{C}$ (BK, BKH Series) : $85 \pm 3^\circ\text{C}$ (BKP, MCF Series)</p> <p>Applied current : Rated current</p> <p>Duration : $500 + 24 / - 0$ hrs</p> <p>Recovery : 2 to 3 hrs of recovery under the standard condition after the removal from test chamber. (See Note 1)</p>
	<p>LK, CK, CKS, CKP, NM, HKQ, AQ, MC Series:</p> <p>Temperature : $85 \pm 2^\circ\text{C}$ (LK, CK, CKS, CKP, NM, MC Series) : $85 \pm 2^\circ\text{C}$ (HK1608, 2125) : $85 \pm 2^\circ\text{C}$ (HK1005, AQ105 operating temperature range $-55 \sim +85^\circ\text{C}$) : $125 \pm 2^\circ\text{C}$ (HKQ0402, HK0603, HK1005, HKQ0603S, HKQ0603U, HKQ0603W, HKQ0603C, AQ105 operating temperature range $-55 \sim +125^\circ\text{C}$)</p> <p>Applied current : Rated current ※MC series ; I_{dc2max}</p> <p>Duration : 500 ± 12 hrs</p> <p>Recovery : 2 to 3 hrs of recovery under the standard condition after the test. (See Note 1)</p>

Note on standard condition: "standard condition" referred to herein is defined as follows:

5 to 35°C of temperature, 45 to 85% relative humidity, and 86 to 106kPa of air pressure.

When there are questions concerning measurement results:

In order to provide correlation data, the test shall be conducted under condition of $20 \pm 2^\circ\text{C}$ of temperature, 60 to 70% relative humidity, and 86 to 106kPa of air pressure. Unless otherwise specified, all the tests are conducted under the "standard condition."

(Note 1) Measurement shall be made after 48 ± 2 hrs of recovery under the standard condition.

Precautions on the use of Multilayer chip inductors

Multilayer chip inductors for high frequency, Multilayer chip bead inductors

Multilayer common mode choke coils (MC series F type)

Metal Multilayer Chip Power Inductors (MCOIL™ MC series)

■ PRECAUTIONS

1. Circuit Design

- Precautions**
- ◆ Verification of operating environment, electrical rating and performance
 1. A malfunction in medical equipment, spacecraft, nuclear reactors, etc. may cause serious harm to human life or have severe social ramifications. As such, any inductors to be used in such equipment may require higher safety and/or reliability considerations and should be clearly differentiated from components used in general purpose applications.
 - ◆ Operating Current (Verification of Rated current)
 1. The operating current including inrush current for inductors must always be lower than their rated values.
 2. Do not apply current in excess of the rated value because the inductance may be reduced due to the magnetic saturation effect.

2. PCB Design

- Precautions**
- ◆ Pattern configurations (Design of Land-patterns)
 1. When inductors are mounted on a PCB, the size of land patterns and the amount of solder used (size of fillet) can directly affect inductor performance. Therefore, the following items must be carefully considered in the design of solder land patterns:
 - (1) The amount of solder applied can affect the ability of chips to withstand mechanical stresses which may lead to breaking or cracking. Therefore, when designing land-patterns it is necessary to consider the appropriate size and configuration of the solder pads which in turn determines the amount of solder necessary to form the fillets.
 - (2) When more than one part is jointly soldered onto the same land or pad, the pad must be designed so that each component's soldering point is separated by solder-resist.
 - (3) The larger size of land patterns and amount of solder, the smaller Q value after mounting on PCB. It makes higher the Q value to design land patterns smaller than terminal electrode of chips.
 - ◆ Pattern configurations (Inductor layout on panelized [breakaway] PC boards)
 1. After inductors have been mounted on the boards, chips can be subjected to mechanical stresses in subsequent manufacturing processes (PCB cutting, board inspection, mounting of additional parts, assembly into the chassis, wave soldering the reflow soldered boards etc.) For this reason, planning pattern configurations and the position of SMD inductors should be carefully performed to minimize stress.

- Technical considerations**
- ◆ Pattern configurations (Design of Land-patterns)
 1. The following diagrams and tables show some examples of recommended patterns to prevent excessive solder amounts (larger fillets which extend above the component end terminations). Examples of improper pattern designs are also shown.
 - (1) Recommended land dimensions for a typical chip inductor land patterns for PCBs

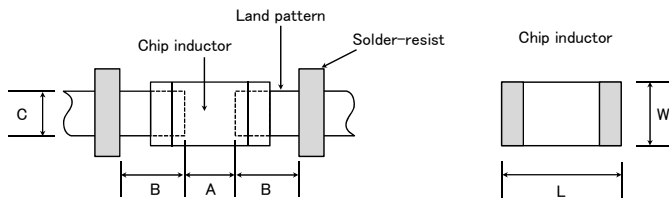

Recommended land dimensions for wave-soldering (Unit: mm)

Type	1608	2012	2125	2016	2520	3216	
Size	L	1.6	2.0	2.0	2.0	2.5	3.2
	W	0.8	1.25	1.25	1.6	2.0	1.6
A	0.8~1.0	1.0~1.4	1.0~1.4	1.0~1.4	1.0~1.4	1.8~2.5	
B	0.5~0.8	0.8~1.5	0.8~1.5	0.8~1.5	0.6~1.0	0.8~1.7	
C	0.6~0.8	0.9~1.2	0.9~1.2	1.3~1.6	1.6~2.0	1.2~1.6	

Recommended land dimensions for reflow-soldering (Unit: mm)

Type	0402	0603	1005	105	1608	2012	2125	2016	2520	3216
Size	L	0.4	0.6	1.0	1.0	1.6	2.0	2.0	2.5	3.2
	W	0.2	0.3	0.5	0.6	0.8	1.25	1.25	1.6	2.0
A	0.15~0.25	0.20~0.30	0.45~0.55	0.50~0.55	0.8~1.0	0.8~1.2	0.8~1.2	0.8~1.2	1.0~1.4	1.8~2.5
B	0.10~0.20	0.20~0.30	0.40~0.50	0.30~0.40	0.6~0.8	0.8~1.2	0.8~1.2	0.8~1.2	0.6~1.0	0.6~1.5
C	0.15~0.30	0.25~0.40	0.45~0.55	0.60~0.70	0.6~0.8	0.9~1.6	0.9~1.6	1.2~2.0	1.8~2.2	1.2~2.0

▶ This catalog contains the typical specification only due to the limitation of space. When you consider the purchase of our products, please check our specification. For details of each product (characteristics graph, reliability information, precautions for use, and so on), see our Web site (<http://www.ty-top.com/>).

Excess solder can affect the ability of chips to withstand mechanical stresses. Therefore, please take proper precautions when designing land-patterns.

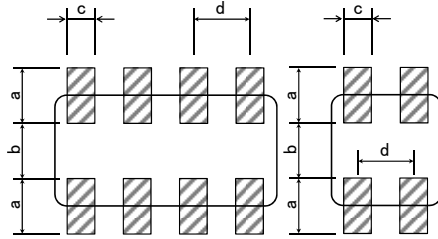

Recommended land dimension for Reflow-soldering

Type	3216	2010	1210	0806	0605	
Size	L	3.2	2.0	1.25	0.85	0.65
	W	1.6	1.0	1.0	0.65	0.50
a	0.7~0.9	0.5~0.6	0.45~0.55	0.25~0.35	0.27~0.33	
b	0.8~1.0	0.5~0.6	0.7~0.8	0.25~0.35	0.17~0.23	
c	0.4~0.5	0.2~0.3	0.25~0.35	0.25~0.35	0.20~0.26	
d	0.8	0.5	0.55	0.5	0.4	

(Unit: mm)

(2) Examples of good and bad solder application

Item	Not recommended	Recommended
Mixed mounting of SMD and leaded components		
Component placement close to the chassis		
Hand-soldering of leaded components near mounted components		
Horizontal component placement		

◆ Pattern configurations (Inductor layout on panelized [breakaway] PC boards)

1-1. The following are examples of good and bad inductor layout; SMD inductors should be located to minimize any possible mechanical stresses from board warp or deflection.

Item	Not recommended	Recommended
Deflection of the board		 Position the component at a right angle to the direction of the mechanical stresses that are anticipated.

1-2. To layout the inductors for the breakaway PC board, it should be noted that the amount of mechanical stresses given will vary depending on inductor layout.

An example below should be counted for better design.

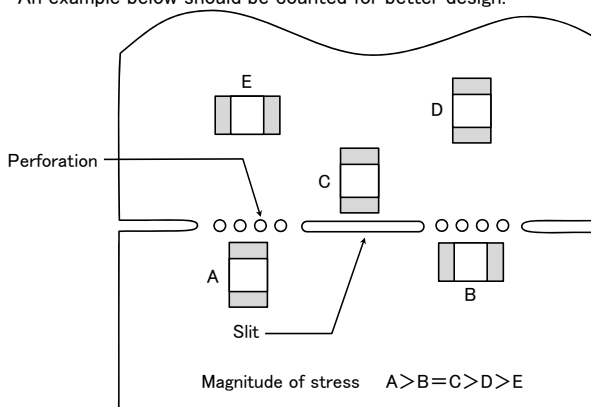

1-3. When breaking PC boards along their perforations, the amount of mechanical stress on the inductors can vary according to the method used. The following methods are listed in order from least stressful to most stressful: push-back, slit, V-grooving, and perforation. Thus, any ideal SMD inductor layout must also consider the PCB splitting procedure.

3. Considerations for automatic placement

Precautions

- ◆ Adjustment of mounting machine
 1. Excessive impact load should not be imposed on the inductors when mounting onto the PC boards.
 2. The maintenance and inspection of the mounter should be conducted periodically.
- ◆ Selection of Adhesives
 1. Mounting inductors with adhesives in preliminary assembly, before the soldering stage, may lead to degraded inductor characteristics unless the following factors are appropriately checked; the size of land patterns, type of adhesive, amount applied, hardening temperature and hardening period. Therefore, it is imperative to consult the manufacturer of the adhesives on proper usage and amounts of adhesive to use.

Technical considerations

- ◆ Adjustment of mounting machine
 1. If the lower limit of the pick-up nozzle is low, too much force may be imposed on the inductors, causing damage. To avoid this, the following points should be considered before lowering the pick-up nozzle:
 - (1) The lower limit of the pick-up nozzle should be adjusted to the surface level of the PC board after correcting for deflection of the board.
 - (2) The pick-up pressure should be adjusted between 1 and 3N static loads.
 - (3) To reduce the amount of deflection of the board caused by impact of the pick-up nozzle, supporting pins or back-up pins should be used under the PC board. The following diagrams show some typical examples of good pick-up nozzle placement:

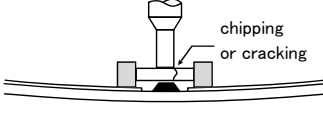
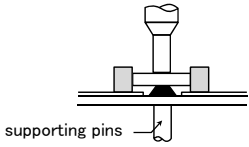
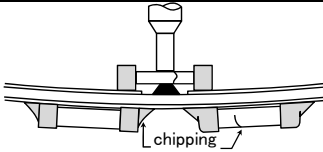
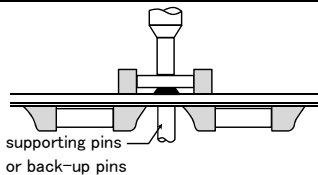
Item	Improper method	Proper method
Single-sided mounting		
Double-sided mounting		

2. As the alignment pin wears out, adjustment of the nozzle height can cause chipping or cracking of the inductors because of mechanical impact on the inductors. To avoid this, the monitoring of the width between the alignment pin in the stopped position, and maintenance, inspection and replacement of the pin should be conducted periodically.

- ◆ Selection of Adhesives
 1. Some adhesives may cause reduced insulation resistance. The difference between the shrinkage percentage of the adhesive and that of the inductors may result in stresses on the inductors and lead to cracking. Moreover, too little or too much adhesive applied to the board may adversely affect component placement, so the following precautions should be noted in the application of adhesives.
 - (1) Required adhesive characteristics
 - a. The adhesive should be strong enough to hold parts on the board during the mounting & solder process.
 - b. The adhesive should have sufficient strength at high temperatures.
 - c. The adhesive should have good coating and thickness consistency.
 - d. The adhesive should be used during its prescribed shelf life.
 - e. The adhesive should harden rapidly.
 - f. The adhesive must not be contaminated.
 - g. The adhesive should have excellent insulation characteristics.
 - h. The adhesive should not be toxic and have no emission of toxic gasses.
 - (2) When using adhesives to mount inductors on a PCB, inappropriate amounts of adhesive on the board may adversely affect component placement. Too little adhesive may cause the inductors to fall off the board during the solder process. Too much adhesive may cause defective soldering due excessive flow of adhesive on to the land or solder pad.

[Recommended conditions]

Figure	0805 case sizes as examples
a	0.3mm min
b	100~120 μm
c	Area with no adhesive

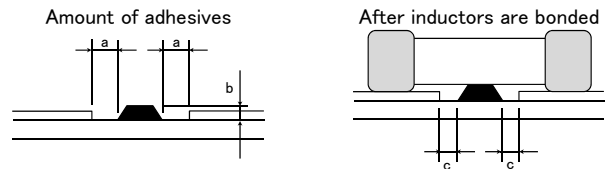

4. Soldering

Precautions

- ◆ Selection of Flux
 1. Since flux may have a significant effect on the performance of inductors, it is necessary to verify the following conditions prior to use;
 - (1) Flux used should be with less than or equal to 0.1 wt% (Chlorine conversion method) of halogenated content. Flux having a strong acidity content should not be applied.
 - (2) When soldering inductors on the board, the amount of flux applied should be controlled at the optimum level.
 - (3) When using water-soluble flux, special care should be taken to properly clean the boards.
- ◆ Soldering
 1. Temperature, time, amount of solder, etc. are specified in accordance with the following recommended conditions, and please contact us about peak temperature when you use lead-free paste.

◆ Selection of Flux

- 1-1. When too much halogenated substance (Chlorine, etc.) content is used to activate the flux, or highly acidic flux is used, an excessive amount of residue after soldering may lead to corrosion of the terminal electrodes or degradation of insulation resistance on the surface of the Inductor.
- 1-2. Flux is used to increase solderability in flow soldering, but if too much is applied, a large amount of flux gas may be emitted and may detrimentally affect solderability. To minimize the amount of flux applied, it is recommended to use a flux-bubbling system.
- 1-3. Since the residue of water-soluble flux is easily dissolved by water content in the air, the residue on the surface of Inductor in high humidity conditions may cause a degradation of insulation resistance and therefore affect the reliability of the components. The cleaning methods and the capability of the machines used should also be considered carefully when selecting water-soluble flux.

◆ Soldering

1-1. Preheating when soldering

Heating: Chip inductor components should be preheated to within 100 to 130°C of the soldering. Cooling: The temperature difference between the components and cleaning process should not be greater than 100°C.

Chip inductors are susceptible to thermal shock when exposed to rapid or concentrated heating or rapid cooling. Therefore, the soldering process must be conducted with a great care so as to prevent malfunction of the components due to excessive thermal shock.

[Reflow soldering]

【Recommended conditions for eutectic soldering】

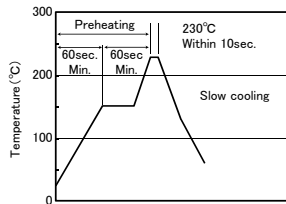

【Recommended condition for Pb-free soldering】

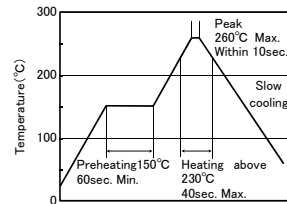

- ※Ceramic chip components should be preheated to within 100 to 130°C of the soldering.
- ※Assured to be reflow soldering for 2 times.
- ※MC series; Peak 230°C (eutectic soldering), 260°C (Pb-free soldering) max within 5sec.

Caution

1. The ideal condition is to have solder mass (fillet) controlled to 1/2 to 1/3 of the thickness of the inductor, as shown below:

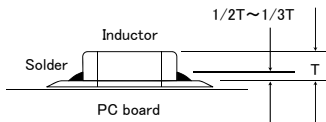

2. Because excessive dwell times can detrimentally affect solderability, soldering duration should be kept as close to recommended times as possible.

[Wave soldering]

【Recommended conditions for eutectic soldering】

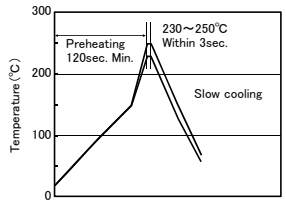

【Recommended condition for Pb-free soldering】

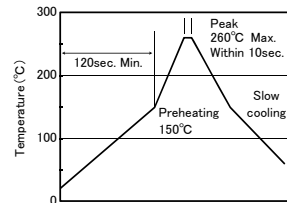

- ※Ceramic chip components should be preheated to within 100 to 130°C of the soldering.
- ※Assured to be wave soldering for 1 time.
- ※Except for reflow soldering type.

Caution

1. Make sure the inductors are preheated sufficiently.
2. The temperature difference between the inductor and melted solder should not be greater than 100 to 130°C.
3. Cooling after soldering should be as gradual as possible.
4. Wave soldering must not be applied to the inductors designated as for reflow soldering only.

[Hand soldering]

【Recommended conditions for eutectic soldering】

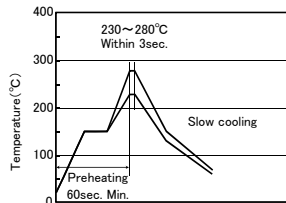

【Recommended condition for Pb-free soldering】

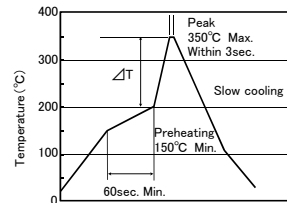

- (※) $\Delta T \leq 190^\circ\text{C}$ (3216 Type max), $\Delta T \leq 130^\circ\text{C}$ (3225 Type min)
- ※It is recommended to use 20W soldering iron and the tip is 1φ or less.
- ※The soldering iron should not directly touch the components.
- ※Assured to be soldering iron for 1 time.
- Note: The above profiles are the maximum allowable soldering condition, therefore these profiles are not always recommended.

Technical considerations

	<p>Caution</p> <ol style="list-style-type: none"> 1. Use a 20W soldering iron with a maximum tip diameter of 1.0 mm. 2. The soldering iron should not directly touch the inductor.
--	--

5. Cleaning

Precautions	<p>◆Cleaning conditions</p> <ol style="list-style-type: none"> 1. When cleaning the PC board after the Inductors are all mounted, select the appropriate cleaning solution according to the type of flux used and purpose of the cleaning (e.g. to remove soldering flux or other materials from the production process.) 2. Cleaning conditions should be determined after verifying, through a test run, that the cleaning process does not affect the inductor's characteristics. 						
Technical considerations	<p>◆Cleaning conditions</p> <ol style="list-style-type: none"> 1. The use of inappropriate solutions can cause foreign substances such as flux residue to adhere to the inductor, resulting in a degradation of the inductor's electrical properties (especially insulation resistance). 2. Inappropriate cleaning conditions (insufficient or excessive cleaning) may detrimentally affect the performance of the inductors. <ol style="list-style-type: none"> (1) Excessive cleaning <ol style="list-style-type: none"> a. In the case of ultrasonic cleaning, too much power output can cause excessive vibration of the PC board which may lead to the cracking of the inductor or the soldered portion, or decrease the terminal electrodes' strength. Thus the following conditions should be carefully checked; <table style="margin-left: 20px; border: none;"> <tr> <td style="padding-right: 20px;">Ultrasonic output</td> <td>Below 20W/l</td> </tr> <tr> <td>Ultrasonic frequency</td> <td>Below 40kHz</td> </tr> <tr> <td>Ultrasonic washing period</td> <td>5 min. or less</td> </tr> </table> 	Ultrasonic output	Below 20W/l	Ultrasonic frequency	Below 40kHz	Ultrasonic washing period	5 min. or less
Ultrasonic output	Below 20W/l						
Ultrasonic frequency	Below 40kHz						
Ultrasonic washing period	5 min. or less						

6. Post cleaning processes

Precautions	<p>◆Application of resin coatings, moldings, etc. to the PCB and components.</p> <ol style="list-style-type: none"> 1. With some type of resins a decomposition gas or chemical reaction vapor may remain inside the resin during the hardening period or while left under normal storage conditions resulting in the deterioration of the inductor's performance. 2. When a resin's hardening temperature is higher than the inductor's operating temperature, the stresses generated by the excess heat may lead to inductor damage or destruction. 3. Stress caused by a resin's temperature generated expansion and contraction may damage inductors. <p>The use of such resins, molding materials etc. is not recommended.</p>
-------------	--

7. Handling

Precautions	<p>◆Breakaway PC boards (splitting along perforations)</p> <ol style="list-style-type: none"> 1. When splitting the PC board after mounting inductors and other components, care is required so as not to give any stresses of deflection or twisting to the board. 2. Board separation should not be done manually, but by using the appropriate devices. <p>◆General handling precautions</p> <ol style="list-style-type: none"> 1. Always wear static control bands to protect against ESD. 2. Keep the inductors away from all magnets and magnetic objects. 3. Use non-magnetic tweezers when handling inductors. 4. Any devices used with the inductors (soldering irons, measuring instruments) should be properly grounded. 5. Keep bare hands and metal products (i.e., metal desk) away from chip electrodes or conductive areas that lead to chip electrodes. 6. Keep inductors away from items that generate magnetic fields such as speakers or coils. <p>◆Mechanical considerations</p> <ol style="list-style-type: none"> 1. Be careful not to subject the inductors to excessive mechanical shocks. <ol style="list-style-type: none"> (1) If inductors are dropped on the floor or a hard surface they should not be used. (2) When handling the mounted boards, be careful that the mounted components do not come in contact with or bump against other boards or components.
-------------	---

8. Storage conditions

Precautions	<p>◆Storage</p> <ol style="list-style-type: none"> 1. To maintain the solderability of terminal electrodes and to keep the packaging material in good condition, care must be taken to control temperature and humidity in the storage area. Humidity should especially be kept as low as possible. <p style="margin-left: 20px;">Recommended conditions</p> <p style="margin-left: 40px;">Ambient temperature Below 30°C</p> <p style="margin-left: 40px;">Humidity Below 70% RH</p> <p>The ambient temperature must be kept below 40°C. Even under ideal storage conditions inductor electrode solderability decreases as time passes, so inductors should be used within 6 months from the time of delivery.</p> <p>*The packaging material should be kept where no chlorine or sulfur exists in the air.</p>
Technical considerations	<p>◆Storage</p> <ol style="list-style-type: none"> 1. If the parts are stocked in a high temperature and humidity environment, problems such as reduced solderability caused by oxidation of terminal electrodes and deterioration of taping/packaging materials may take place. For this reason, components should be used within 6 months from the time of delivery. If exceeding the above period, please check solderability before using the inductors.

▶ This catalog contains the typical specification only due to the limitation of space. When you consider the purchase of our products, please check our specification. For details of each product (characteristics graph, reliability information, precautions for use, and so on), see our Web site (<http://www.ty-top.com/>).