

LESD11D3.3CT5G ESD PROTECTION DIODE

Discription

The LESD11D3.3CT5G is designed to protect voltage sensitive components from ESD. Excellent clamping capability, low leakage, and fast response time ,make these parts ideal for ESD protection on designs where board space is at a premium. Because of its small size, it is suited for use in cellular phones, MP3 players, digital cameras and many other portable applications where board space is at a premium.

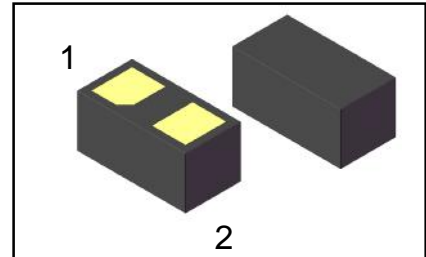
Applications

- | Cellular phones audio
- | MP3 players
- | Digital cameras
- | Portable applications
- | mobile telephone

Features

- | Small Body Outline Dimensions: 0.61 mm x 0.31 mm
- | Low Body Height: 0.28 mm
- | Low Leakage
- | Response Time is Typically < 1 ns
- | ESD Rating of Class 3 (> 16 kV) per Human Body Model
- | IEC61000-4-2 Level 4 ESD Protection
- | These are Pb-Free Devices
- | We declare that the material of product compliance with RoHS requirements.

LESD11D3.3CT5G



DFN0603-D



Ordering information

Device	Marking	Shipping
LESD11D3.3CT5G	B	15000/Tape&Reel

MAXIMUM RATINGS

Rating	Symbol	Value	Unit
IEC 61000-4-2 (ESD) Air discharge Contact discharge		±25 ±20	kV kV
ESD Voltage Per Human Body Model		16	kV
Total Power Dissipation on FR-5 Board (Note 1) @ T _A =25°C	PD	200	mW
Junction and Storage Temperature Range	T _J ,T _{STG}	-55 to 150	°C
Lead Solder Temperature – Maximum (10 Second Duration)	TL	260	°C

Stresses exceeding Maximum Ratings may damage the device. Maximum Rating are stress ratings only. Functional operation above the Recommended Operating Conditions is not implied. Extended exposure to stresses above the Recommended Operating Conditions may affect device reliability.

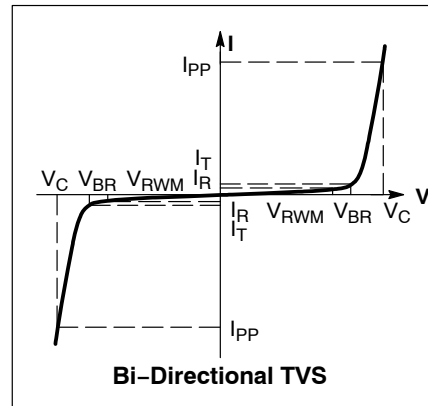
1. FR-5 = 1.0*0.75*0.62 in.

LESD11D3.3CT5G

ELECTRICAL CHARACTERISTICS

($T_A = 25^\circ\text{C}$ unless otherwise noted)

Symbol	Parameter
I_{PP}	Maximum Reverse Peak Pulse Current
V_C	Clamping Voltage @ I_{PP}
V_{RWM}	Working Peak Reverse Voltage
I_R	Maximum Reverse Leakage Current @ V_{RWM}
V_{BR}	Breakdown Voltage @ I_T
I_T	Test Current
P_{pk}	Peak Power Dissipation
C	Capacitance @ $V_R = 0$ and $f = 1.0$ MHz



ELECTRICAL CHARACTERISTICS

Device	V_{RWM} (V)	I_R (μA) @ V_{RWM}	V_{BR} (V) @ I_T (Note 2)		I_T	V_C (V) @ $I_{PP} = 1$ A (Note 3)	V_C (V) @ MAX I_{PP} (Note 3)	I_{PP} (A) (Note 3)	P_{PK} (W) (Note 3)	C (pF)
	Max	Max	Min	Max	mA	Max	Max	Max	Max	Max
LESD11D3.3CT5G	3.3	0.1	5.0	6.5	1.0	7	10	6	60	16

Other voltage available upon request.

- V_{BR} is measured with a pulse test current I_T at an ambient temperature of 25°C
- Surge current waveform per Figure 1.

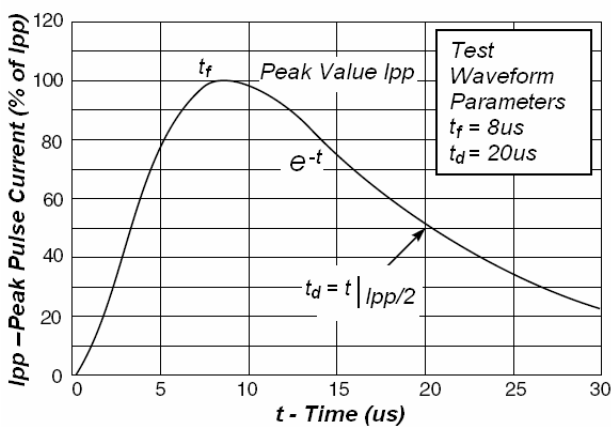


Fig1. Pulse Waveform

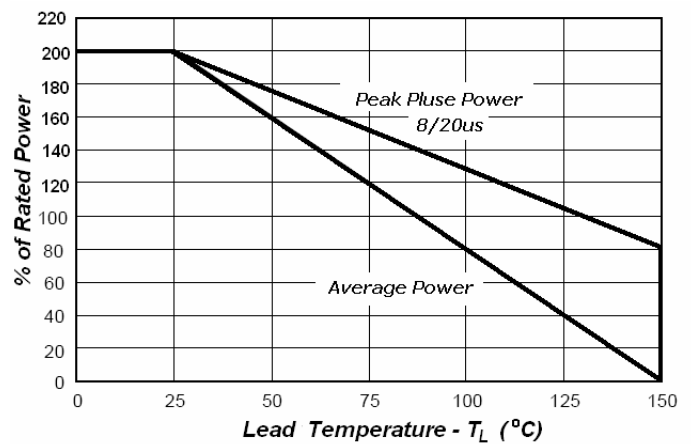


Fig2. Power Derating Curve

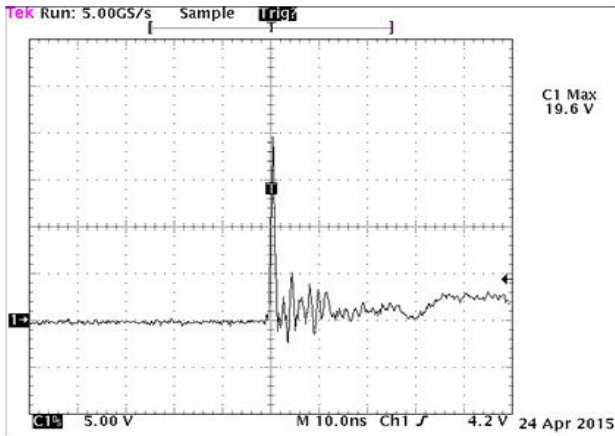
LESD11D3.3CT5G

Fig4.Positive 8 kV Contact per IEC61000.4.2

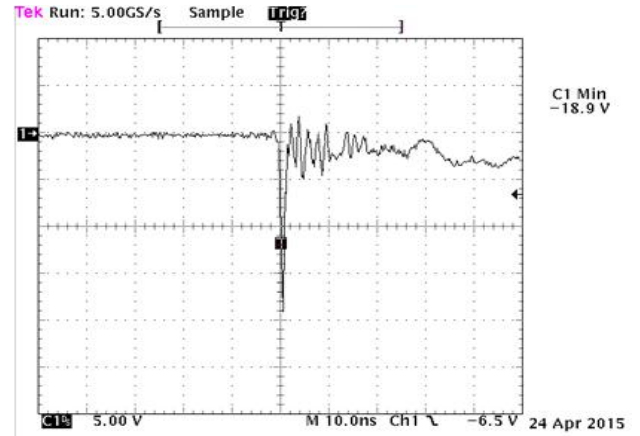
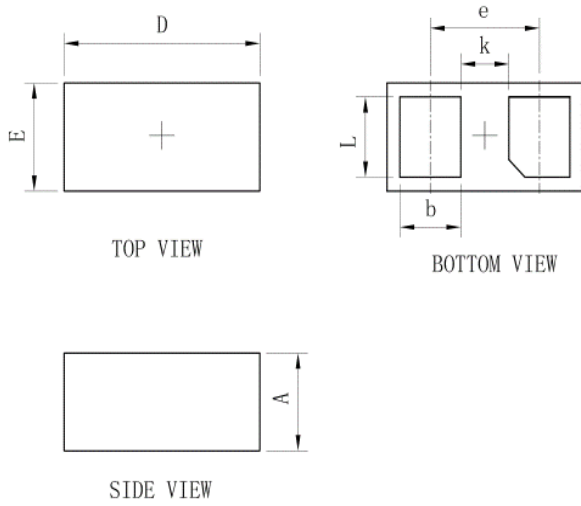


Fig5.Negative 8 kV Contact per IEC61000.4.2

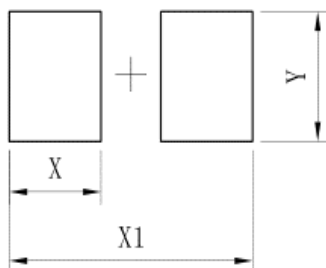
LESD11D3.3CT5G

OUTLINE AND DIMENSIONS



DFN0603-DL			
Dim	Min	Typ.	Max
D	0.58	0.61	0.64
E	0.28	0.31	0.34
e	-	0.34	-
L	0.20	0.23	0.26
b	0.16	0.19	0.22
A	0.25	0.28	0.31
k	0.12	0.15	0.18
All Dimensions in mm			

SOLDERING FOOTPRINT



DFN0603-DL	
DIM	(mm)
X	0.23
X1	0.61
Y	0.30